

Adapter

Messing, Edelstahl,
PVDF, PA

Adaptateurs





















Laiton, acier inoxydable,
PVDF, PA

Adaptors

Brass, stainless steel,
PVDF, PA



	Seite/Page/Page		Seite/Page/Page		Seite/Page/Page
Adapter Messing M Adaptateurs laiton M Adaptors brass M		Aufschraub-T Té femelle Female threaded tee	674		Adapter Messing G Adaptateurs laiton G Adaptors brass G
				AD FT 40	
Doppelnippel Mamelon double Male threaded adaptor	666-667	Einschraubtülle Douille cannelée à visser Male adaptor hose nozzle	675		678-679
				AD HN 40	SO 01020
Übergangsmuffe Adaptateur femelle - femelle Female adaptor	667-668	Adapter Messing CV Adaptateurs laiton CV Adaptors brass CV			680
				AD FA 40	SO 01200
Übergangsnippel Adaptateur femelle - mâle Adaptor female - male	668-670	Übergangsmuffe Adaptateur femelle - femelle Female adaptor	676		680
				AD A 40	SO 01500
Sechskantmuffe Manchon hexagonal Hexagonal threaded socket	670	Übergangsnippel Adaptateur femelle - mâle Adaptor female - male	676-677		681-682
				AD HC 40	SO 02000
Rohrkappe Capuchon Hexagonal cap	671	Verschlusschraube Bouchon fileté Screw plug	677		682
				AD HCP 40	SO 03000
Verschlusschraube Bouchon fileté Screw plug	671-674	Einschraubtülle Douille cannelée à visser Male adaptor hose nozzle	677		Sonderausführungen auf Anfrage Exécution en option sur demande Optional services on request
				AD HP 40	Spezialreinigung - entfettet Traitement spécial - dégraissé Special treatment - degreased
Aufschraub-Winkel Coude femelle Female threaded elbow	674				Vorbeschichtete Gewinde PTFE-Band umwickelt Filetages pré enduits avec ruban en PTFE Pre-coated threads with PTFE-tape
				AD FE 40	Vorbeschichtete Gewinde mit Loctite 5061 Filetages pré enduits avec Loctite 5061 Pre-coated threads with Loctite 5061
					Chemisch vernickelt Nickelage chimique Chemical nickel-plated

Seite/Page/Page		Seite/Page/Page		Seite/Page/Page
	<p>Adapter Edelstahl Adaptateurs acier inoxydable Adaptors stainless steel</p>			
		<p>Muffe kurz Manchon court Threaded socket short</p>	<p>691</p>  <p>AD CS 50</p>	<p>697</p> <p>Aufschraub-T Té femelle Female threaded tee</p>  <p>AD FT 51</p>
	<p>Doppelnippel Mamelon double Male threaded adaptor</p>	<p>684-685</p>  <p>AD HN 50</p>	<p>691</p> <p>Hochdruckanschweissmuffe Manchon à souder pour haute pression High-pressure weld-on socket</p>  <p>AD FCW 50 NPT</p>	<p>698-699</p> <p>Einschraubtülle Douille cannelée à visser Male adaptor hose nozzle</p>  <p>SO 50511</p>
	<p>Sechskantnippel Adaptateur hexagonal Hexagonal nipple</p>	<p>686</p>  <p>ADH A 50</p>	<p>691-692</p> <p>Sechskantmuffe Manchon hexagonal Hexagonal threaded socket</p>  <p>AD HC 50</p>	<p>Sonderausführungen auf Anfrage Exécution en option sur demande Optional services on request</p> <p> Spezialreinigung - entfettet Traitement spécial - dégraissé Special treatment - degreased</p> <p> Vorbeschichtete Gewinde mit Loctite 5061 Filetages pré enduits avec Loctite 5061 Pre-coated threads with Loctite 5061</p>
	<p>Rohrdoppelnippel Mamelon double tubulaire Tube double threaded nipple</p>	<p>686</p>  <p>AD CN 50</p>	<p>692</p> <p>Rohrkappe Capuchon Hexagonal cap</p>  <p>AD HCP 50</p>	<p>Bestätigungen auf www.serto.com Confirmations sur www.serto.com Confirmations on www.serto.com</p> <p> FDA</p>
	<p>Rohrnippel Mamelon tubulaire Tube nipple</p>	<p>687</p>  <p>AD CNS 50</p>	<p>692-695</p> <p>Verschlusschraube Bouchon fileté Screw plug</p>  <p>AD HP 50</p>	
	<p>Rohranschweissnippel Embout fileté à souder Weld-on nipple</p>	<p>687</p>  <p>AD CNW 50</p>	<p>696</p> <p>Sechskant-Kontermutter Contre-écrou à six pans Hexagonal counter nut</p>  <p>AD HCN 50</p>	<p>700</p> <p>Einschraubtülle Douille cannelée à visser Male adaptor hose nozzle</p>  <p>SO 10511 OR</p>
	<p>Übergangsnippel Adaptateur femelle - mâle Adaptor female - male</p>	<p>688-690</p>  <p>AD A 50</p>	<p>696</p> <p>Aufschraub-Winkel Coude femelle Female threaded elbow</p>  <p>AD FE 51</p>	
	<p>Muffe lang Manchon long Threaded socket long</p>	<p>690</p>  <p>AD C 50</p>	<p>697</p> <p>Einschraub-/Aufschraub-Winkel Coude mâle - femelle Male/female threaded elbow</p>  <p>AD SE 51</p>	

Seite/Page/Page

Seite/Page/Page

Seite/Page/Page

Adapter PVDF
Adaptateurs PVDF
Adaptors PVDF

Adapter PA
Adaptateurs PA
Adaptors PA

Diverses
Divers
Various

Übergangsmuffe
 Adaptateur femelle - femelle
 Female adaptor



702
SO 20031

Einschraubtülle
 Douille cannelée à visser
 Male adaptor hose nozzle



705
SO 30511

Rohrkompenzierverbindung
 Compensateur de tube
 Tube compensator



708
RK 51900

Übergangsnippel
 Adaptateur femelle - mâle
 Adaptor female - male



702-703
SO 20041

Sonderausführungen auf Anfrage
Exécution en option sur demande
Optional services on request



Vorbeschichtete Gewinde mit Loctite 5061
 Filetages pré enduits avec Loctite 5061
 Pre-coated threads with Loctite 5061

Verschlusschraube
 Bouchon fileté
 Screw plug



703
SO 20371

Einschraubtülle
 Douille cannelée à visser
 Male adaptor hose nozzle



703
SO 20511

Doppelnippel
 Mamelon double
 Male threaded adaptor



704
SO 21109

Bestätigungen auf www.serto.com
Confirmations sur www.serto.com
Confirmations on www.serto.com



Adapter Messing

Eigenschaften, Besonderheiten

- einfache Verbindungselemente mit Innen- und Aussengewinden, Tüllen und Abschlusselementen
- zahlreiche Bauformen
- viele Kombinationsmöglichkeiten

Betriebsdruck

niedrige bis mittlere Drücke

Werkstoff

Messing CW 617N (CuZn40Pb2), Oberfläche gebeizt.
Detailangaben chemische Vernickelung siehe Kapitel 2.

Herstellung

Messing M und CV:

- gerade Verbinder: gefertigt aus Vollmaterial
- Typen AD FE/FT: Druckguss

Messing G:

gefertigt aus Vollmaterial

Gewinde

G = Rohrgewinde BSP (zylindrisch) ISO 228
R = Rohrgewinde (kegelig) EN 10226-1
NPT = Rohrgewinde (kegelig) ANSI B 1.20.1

Adaptateurs laiton

Propriétés, spécificités

- éléments simples d'assemblage avec des filetages intérieurs et extérieurs, des douilles et des éléments de fermeture
- grand nombre de formes de construction
- nombreuses possibilités de combinaison

Pression de service

pression faible à moyenne

Matériaux

Laiton CW 617N (CuZn40Pb2), la surface est décapée.
Détails du nickelage chimique voir chapitre 2.

Fabrication

Laiton M et CV:

- connecteurs droits: fabriqués de matériel plein
- types AD FE/FT: moulage sous pression

Laiton G:

fabriqués de matériel plein

Filetages

G = filetage gas BSP (cylindrique) ISO 228
R = filetage gas BSP (conique) EN 10226-1
NPT = filetage NPT (conique) ANSI B 1.20.1

Adaptors brass

Characteristics, specialities

- simple connecting pieces with internal and external threads, hose nozzles and end elements
- large number of design types
- many possible combinations

Working pressure

low to medium pressure

Material

Brass CW 617N (CuZn40Pb2), the surface is pickled.
Details for nickel-plated brass see chapter 2.

Manufacture

Brass M and CV:

- straight connectors: made of solid material
- types AD FE/FT: die casting

Brass G:

made of solid material

Threads

G = BSP pipe thread (parallel) ISO 228
R = BSP pipe thread (tapered) EN 10226-1
NPT = NPT pipe thread (tapered) ANSI B 1.20.1

Doppelnippel R-R

Mamelon double R-R

Male threaded adaptor R-R

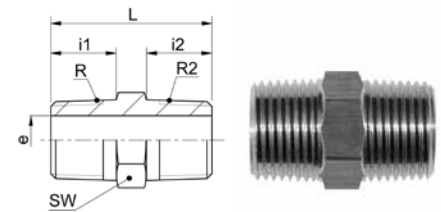

AD HN 40 R

Type -R-R2	Mat.-Nr.	SW	L	i1	i2	e	kg/100
R=Rohrgewinde (kegelig)		R=Filetage-gaz BSP (conique)			R=BSP thread (tapered)		
R2=Rohrgewinde (kegelig)		R2=Filetage-gaz BSP (conique)			R2=BSP thread (tapered)		
AD HN 40-1/8 -1/8	TAD.4110.042	10	21.0	8.0	8.0	6.0	0.760
AD HN 40-1/8 -1/4	TAD.4110.044	14	26.0	8.0	12.0	6.0	1.200
AD HN 40-1/4 -1/4	TAD.4110.104	14	30.0	12.0	12.0	8.0	1.610
AD HN 40-1/4 -3/8	TAD.4110.106	17	31.0	12.0	12.0	8.0	2.010
AD HN 40-1/4 -1/2	TAD.4110.108	22	34.0	12.0	14.0	8.0	2.980
AD HN 40-3/8 -3/8	TAD.4110.166	17	30.0	12.0	12.0	10.5	3.240
AD HN 40-3/8 -1/2	TAD.4110.168	22	34.0	12.0	14.0	10.0	4.930
AD HN 40-1/2 -1/2	TAD.4110.228	22	36.0	14.0	14.0	14.0	5.420
AD HN 40-1/2 -3/4	TAD.4110.232	27	39.0	14.0	16.0	14.0	8.360
AD HN 40-1/2 -1	TAD.4110.236	36	43.0	14.0	18.0	14.0	15.240
AD HN 40-3/4 -3/4	TAD.4110.292	27	41.0	16.0	16.0	18.0	9.410
AD HN 40-1 -1	TAD.4110.414	36	51.0	18.0	18.0	24.0	17.760

Doppelnippel R-NPT

Mamelon double R-NPT

Male threaded adaptor R-NPT

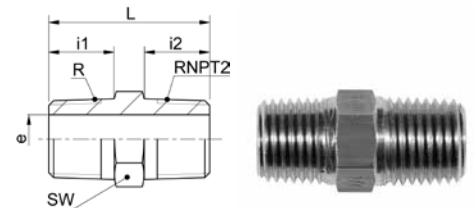

AD HN 40 R-NPT

Type -R-RNPT2	Mat.-Nr.	SW	L	i1	i2	e	kg/100
R=Rohrgewinde (kegelig)		R=Filetage-gaz BSP (conique)			R=BSP thread (tapered)		
RNPT2=NPT Gewinde		RNPT2=Filetage NPT			RNPT2=NPT thread		
AD HN 40-1/8-1/8 NPT	TAD.4114.042	12	24.5	10.0	10.0	6.0	1.240
AD HN 40-1/4-1/4 NPT	TAD.4114.104	14	32.0	12.0	14.0	8.0	1.700
AD HN 40-3/8-3/8 NPT	TAD.4114.166	17	34.0	14.0	14.0	10.5	4.370
AD HN 40-1/2-1/2 NPT	TAD.4114.228	22	45.0	19.0	19.0	13.0	8.260
AD HN 40-1-1 NPT	TAD.4114.414	36	60.0	25.0	25.0	23.0	23.550

Doppelnippel NPT-NPT

Mamelon double NPT-NPT

Male threaded adaptor NPT-NPT

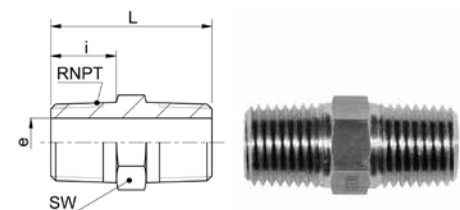

AD HN 40 NPT-NPT

Type -RNPT	Mat.-Nr.	SW	L	i	e	kg/100
RNPT=NPT Gewinde		RNPT=Filetage NPT			RNPT=NPT thread	
AD HN 40-1/8 NPT-1/8 NPT	TAD.4111.042	12	24.5	10.0	6.0	1.150
AD HN 40-1/4 NPT-1/4 NPT	TAD.4111.104	14	34.0	14.0	8.0	2.720
AD HN 40-3/8 NPT-3/8 NPT	TAD.4111.166	17	34.0	14.0	10.5	3.950
AD HN 40-1/2 NPT-1/2 NPT	TAD.4111.228	22	45.0	19.0	13.0	8.240

Doppelnippel G

60°-Innenkonus

Mamelon double G

cône intérieur 60°

Male threaded adaptor G

60° inner cone

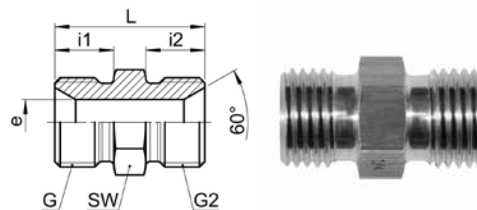

ADH HNC 40

Type -G -G2	Mat.-Nr.	SW	L	i1	i2	e	kg/100
G=Rohrgewinde (zylindrisch)							
G2=Rohrgewinde (zylindrisch)							
ADH HNC 40-1/4-1/4	496.4100.104	14	26.0	10.0	10.0	7.5	1.690
ADH HNC 40-1/4-3/8	496.4100.106	14	27.0	10.0	11.0	7.5	2.330
ADH HNC 40-3/8-3/8	496.4100.166	17	28.0	11.0	11.0	8.5	3.160

Übergangsmuffe G-G

Adaptateur femelle G - femelle G

Female adaptor G-G

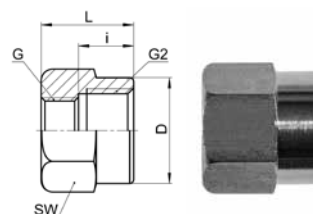

AD FA 40

Type -G -G2	Mat.-Nr.	SW	L	D	i	kg/100
G=Rohrgewinde (zylindrisch)						
G2=Rohrgewinde (zylindrisch)						
AD FA 40-1/8-1/8	016.0311.042	14	16.0	13.8	8.0	1.240
AD FA 40-1/8-1/4	016.0311.044	17	19.0	16.8	9.0	2.170
AD FA 40-1/8-3/8	016.0311.046	22	20.0	21.8	9.5	4.160
AD FA 40-1/8-1/2	016.0311.048	27	22.0	26.8	11.5	6.940
AD FA 40-1/4-1/4	016.0311.104	17	18.0	16.8	9.0	1.710
AD FA 40-1/4-3/8	016.0311.106	22	21.0	21.8	9.5	4.060
AD FA 40-1/4-1/2	016.0311.108	27	23.0	26.8	11.5	6.900
AD FA 40-3/8-3/8	016.0311.166	22	19.0	21.8	9.5	3.090
AD FA 40-3/8-1/2	016.0311.168	27	23.5	26.8	11.5	6.520
AD FA 40-1/2-1/2	016.0311.228	27	23.0	26.8	11.5	5.450
AD FA 40-3/4-3/8	016.0311.286	32	26.5	31.8	9.5	7.830
AD FA 40-3/4-1/2	016.0311.288	32	28.5	31.8	11.5	9.870
AD FA 40-3/4-3/4	016.0311.292	32	28.0	31.8	14.0	7.580

Übergangsmuffe G-NPT

Adaptateur femelle G - femelle NPT

Female adaptor G-NPT

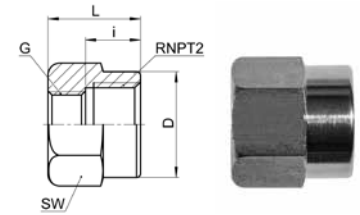

AD FA 40 NPT

Type -G -RNPT2	Mat.-Nr.	SW	L	D	i	kg/100
G=Rohrgewinde (zylindrisch)	G=Filetage-gaz BSP (cylindrique)	G=BSP thread (parallel)				
RNPT2=NPT Gewinde	RNPT2=Filetage NPT	RNPT2=NPT thread				
AD FA 40-1/8-1/8 NPT	016.0312.042	14	20.0	13.8	10.0	1.340
AD FA 40-1/8-1/4 NPT	016.0312.044	19	22.0	18.8	14.0	3.970
AD FA 40-1/8-3/8 NPT	016.0312.046	22	22.0	21.8	14.0	4.260
AD FA 40-1/4-1/8 NPT	016.0312.102	17	18.5	16.8	7.5	2.710
AD FA 40-1/4-1/4 NPT	016.0312.104	19	25.0	18.8	14.0	4.300
AD FA 40-1/4-3/8 NPT	016.0312.106	22	23.0	21.8	14.0	4.060
AD FA 40-3/8-1/4 NPT	016.0312.164	22	21.0	21.8	9.0	3.670
AD FA 40-3/8-3/8 NPT	016.0312.166	22	26.0	21.8	14.0	4.270
AD FA 40-3/8-1/2 NPT	016.0312.168	27	28.0	26.8	18.0	6.870
AD FA 40-1/2-1/4 NPT	016.0312.224	27	23.0	19.8	9.0	6.030
AD FA 40-1/2-3/8 NPT	016.0312.226	27	24.0	26.8	10.0	6.520
AD FA 40-1/2-1/2 NPT	016.0312.228	27	32.0	26.8	18.0	6.850

Übergangsnippel G-R

Adaptateur femelle G - mâle R

Adaptor female G - male R

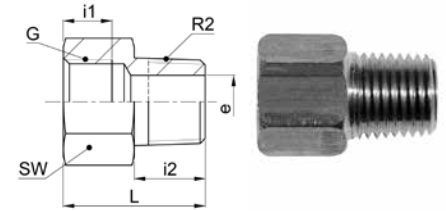

AD A 40 G-R

Type -G -R2	Mat.-Nr.	SW	L	i1	i2	e	kg/100
G=Rohrgewinde (zylindrisch)	G=Filetage-gaz BSP (cylindrique)	G=BSP thread (parallel)					
R2=Rohrgewinde (kegelig)	R2=Filetage-gaz BSP (conique)	R2=BSP thread (tapered)					
AD A 40-1/8-1/8	016.0411.042	14	21.0	8.0	8.0	5.0	2.100
AD A 40-1/8-1/4	016.0411.044	14	17.5	8.0	12.0	8.6	1.060
AD A 40-1/8-3/8	016.0411.046	17	18.0	8.0	12.0	8.6	2.280
AD A 40-1/8-1/2	016.0411.048	22	23.0	9.6	16.0	14.0	3.970
AD A 40-1/4-1/8	016.0411.102	17	21.0	9.0	8.0	5.0	1.630
AD A 40-1/4-1/4	016.0411.104	17	26.0	9.0	12.0	8.5	2.600
AD A 40-1/4-3/8	016.0411.106	17	20.0	9.0	12.0	11.4	1.690
AD A 40-1/4-1/2	016.0411.108	22	23.0	9.7	16.0	14.0	3.590
AD A 40-1/4-3/4	016.0411.110	27	25.5	11.2	16.5	19.0	9.050
AD A 40-3/8-1/8	016.0411.162	22	24.0	9.5	8.0	5.0	3.490
AD A 40-3/8-1/4	016.0411.164	22	27.0	9.5	12.0	8.5	3.180
AD A 40-3/8-3/8	016.0411.166	22	27.0	9.5	12.0	10.5	4.500
AD A 40-3/8-1/2	016.0411.168	22	26.0	9.5	16.0	15.0	2.740
AD A 40-3/8-3/4	016.0411.170	27	25.5	9.5	16.5	14.8	7.510
AD A 40-1/2-1/4	016.0411.224	27	29.0	11.5	12.0	8.5	5.852
AD A 40-1/2-3/8	016.0411.226	27	29.0	11.5	12.0	10.5	5.720
AD A 40-1/2-1/2	016.0411.228	27	32.0	11.5	14.0	13.0	8.200
AD A 40-1/2-3/4	016.0411.232	27	27.5	11.5	16.5	18.6	5.133
AD A 40-1/2-1	016.0411.236	36	31.0	12.5	18.5	24.0	13.100
AD A 40-3/4-3/8	016.0411.286	32	33.5	14.0	12.0	10.5	8.900
AD A 40-3/4-1/2	016.0411.288	32	37.5	14.0	16.0	14.0	11.000
AD A 40-3/4-3/4	016.0411.292	32	38.0	14.0	16.5	19.0	9.400
AD A 40-3/4-1	016.0411.296	36	34.0	14.0	20.0	24.1	13.900

Übergangsnippel G-NPT

Adaptateur femelle G - mâle NPT

Adaptor female G - male NPT

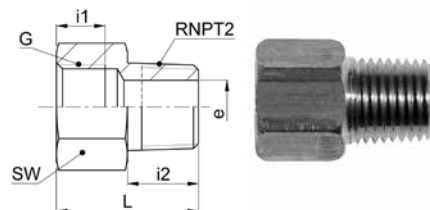

AD A 40 G-NPT

Type -G -RNPT2	Mat.-Nr.	SW	L	i1	i2	e	kg/100
G=Rohrgewinde (zylindrisch)	G=Filetage-gaz BSP (cylindrique)		G=BSP thread (parallel)				
RNPT2=NPT Gewinde	RNPT2=Filetage NPT		RNPT2=NPT thread				
AD A 40-1/8-1/8 NPT	016.0412.042	14	23.0	8.0	10.0	6.0	2.300
AD A 40-1/8-1/4 NPT	016.0412.044	14	20.0	8.0	14.0	8.6	1.200
AD A 40-1/4-1/8 NPT	016.0412.102	17	24.5	9.0	10.0	6.0	3.000
AD A 40-1/4-1/4 NPT	016.0412.104	17	26.5	9.0	14.0	8.5	3.900
AD A 40-1/4-3/8 NPT	016.0412.106	17	21.0	9.0	14.0	10.5	2.800
AD A 40-1/4-1/2 NPT	016.0412.108	22	27.0	9.0	19.0	11.4	7.700
AD A 40-3/8-1/4 NPT	016.0412.164	22	29.5	9.5	14.0	8.5	5.900
AD A 40-3/8-3/8 NPT	016.0412.166	22	29.5	9.5	14.0	10.5	6.800
AD A 40-3/8-1/2 NPT	016.0412.168	22	27.0	9.5	19.0	14.0	5.400
AD A 40-3/8-3/4 NPT	016.0412.170	27	29.0	9.5	20.0	15.0	12.800
AD A 40-1/2-1/4 NPT	016.0412.224	27	32.0	11.5	14.0	8.5	6.900
AD A 40-1/2-3/8 NPT	016.0412.226	27	32.0	11.5	14.0	10.5	7.100
AD A 40-1/2-1/2 NPT	016.0412.228	27	37.5	11.5	19.0	14.0	11.100
AD A 40-1/2-3/4 NPT	016.0412.232	27	31.0	11.5	20.0	18.6	8.900
AD A 40-3/4-3/4 NPT	016.0412.292	32	41.5	14.0	20.0	19.0	17.200
AD A 40-3/4-1 NPT	016.0412.296	36	33.0	14.0	25.0	24.1	16.500
AD A 40-1-1 NPT	016.0412.414	41	45.0	17.0	25.0	23.0	21.600

Übergangsnippel NPT-R

Adaptateur femelle NPT - mâle R

Adaptor female NPT - male R

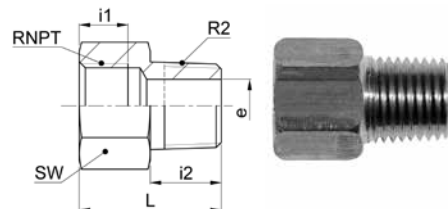

AD A 40 NPT-R

Type -RNPT -R2	Mat.-Nr.	SW	L	i1	i2	e	kg/100
RNPT=NPT Gewinde	RNPT=Filetage NPT		RNPT=NPT thread				
R2=Rohrgewinde (kegelig)	R2=Filetage-gaz BSP (conique)		R2=BSP thread (tapered)				
AD A 40-1/8 NPT-1/8	016.0414.042	14	21.0	10.0	8.0	6.0	1.470
AD A 40-1/8 NPT-1/4	016.0414.044	14	18.0	10.0	12.0	8.1	1.130
AD A 40-1/4 NPT-1/4	016.0414.104	17	29.0	14.0	12.0	8.5	2.740
AD A 40-1/4 NPT-3/8	016.0414.106	17	22.0	14.0	12.0	10.5	1.650
AD A 40-1/2 NPT-1/2	016.0414.228	27	38.0	18.0	16.0	14.0	8.310

Übergangsnippel NPT-NPT

Adaptateur femelle NPT - mâle NPT

Adaptor female NPT - male NPT

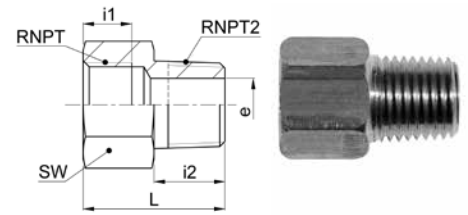

AD A 40 NPT-NPT

Type -RNPT -RNPT2	Mat.-Nr.	SW	L	i1	i2	e	kg/100
RNPT=NPT Gewinde RNPT2=NPT Gewinde		RNPT=Filetage NPT RNPT2=Filetage NPT				RNPT=NPT thread RNPT2=NPT thread	
AD A 40-1/4 NPT-1/8 NPT	016.0415.102	17	27.5	14.0	10.0	4.5	2.450
AD A 40-1/4 NPT-1/4 NPT	016.0415.104	17	31.5	14.0	14.0	8.5	2.600
AD A 40-1/4 NPT-1/2 NPT	016.0415.108	22	27.0	10.0	19.0	14.0	5.200
AD A 40-1/2 NPT-1/4 NPT	016.0415.224	27	37.0	13.5	14.0	8.5	8.600
AD A 40-1/2 NPT-3/8 NPT	016.0415.226	27	37.0	13.5	14.0	10.5	9.200

Sechskantmuffe

Manchon hexagonal

Hexagonal threaded socket

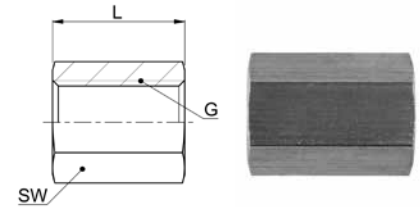

AD HC 40

Type -G	Mat.-Nr.	SW	L	kg/100
G=Rohrgewinde (zylindrisch)		G=Filetage-gaz BSP (cylindrique)		G=BSP thread (parallel)
AD HC 40-1/8	TAD.4100.042	14	22.0	1.240
AD HC 40-1/4	TAD.4100.104	17	26.0	1.710
AD HC 40-3/8	TAD.4100.166	22	26.0	3.090
AD HC 40-1/2	TAD.4100.228	27	30.0	7.800
AD HC 40-3/4	TAD.4100.292	32	36.0	11.170
AD HC 40-1	TAD.4100.414	41	36.0	21.400

Sechskantmuffe reduziert

Manchon hexagonal réduit

Hexagonal threaded socket reduced

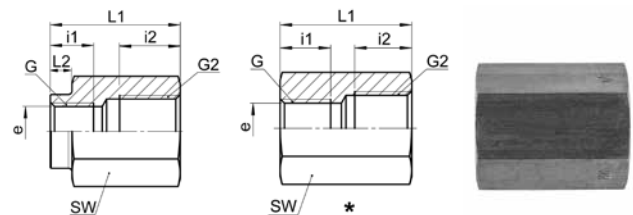

AD HRC 40

Type -G -G2	Mat.-Nr.	SW	L1	L2	i1	i2	e	kg/100
G=Rohrgewinde (zylindrisch)		G=Filetage-gaz BSP (cylindrique)					G=BSP thread (parallel)	
G2=Rohrgewinde (zylindrisch)		G2=Filetage-gaz BSP (cylindrique)					G2=BSP thread (parallel)	
AD HRC 40-1/8 -1/4 *	TAD.4100.044	22	25.0	0.0	8.0	12.0	8.5	7.060
AD HRC 40-1/8 -3/8	TAD.4100.046	22	20.0	4.0	8.0	10.5	8.5	4.160
AD HRC 40-1/4 -3/8 *	TAD.4100.106	22	30.0	0.0	12.0	12.0	11.4	7.050
AD HRC 40-1/4 -1/2	TAD.4100.108	27	24.0	7.0	10.0	11.5	11.4	6.900
AD HRC 40-1/4 -3/4	TAD.4100.110	32	26.0	5.0	9.0	14.0	11.4	7.580
AD HRC 40-3/8 -1/2 *	TAD.4100.168	27	34.0	0.0	12.0	14.0	14.9	11.550
AD HRC 40-1/2 -3/4 *	TAD.4100.232	32	28.5	0.0	11.5	14.0	18.6	10.700
AD HRC 40-1/2 -1 *	TAD.4100.236	41	31.5	0.0	11.5	17.0	18.6	21.400

Rohrkappe G

mit EPDM-Dichtung

Capuchon G

avec joint EPDM

Hexagonal cap G

with EPDM sealing

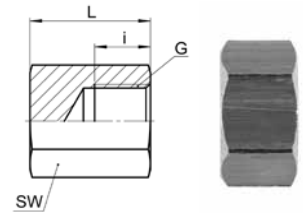

AD HCP 40

Type -G	Mat.-Nr.	SW	L	i	kg/100
G=Rohrgewinde (zylindrisch)		G=Filetage-gaz BSP (cylindrique)		G=BSP thread (parallel)	
AD HCP 40-1/8	TAD.4000.020	14	10.0	8.0	0.980
AD HCP 40-1/4	TAD.4000.040	17	10.0	8.0	1.170
AD HCP 40-3/8	TAD.4000.060	19	10.0	8.0	3.460
AD HCP 40-1/2	TAD.4000.080	23	12.0	10.0	6.490
AD HCP 40-3/4	TAD.4000.120	30	14.5	12.0	11.490
AD HCP 40-1	TAD.4000.160	36	14.5	12.0	23.760

Verschlusschraube R

mit Aussen-6kt.

Bouchon fileté R

à six pans

Screw plug R

with hex-nut

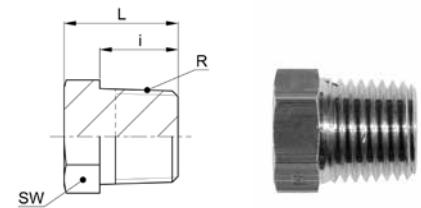

AD HP 40 R

Type -R	Mat.-Nr.	SW	L	i	kg/100
R=Rohrgewinde (kegelig)		R=Filetage-gaz BSP (conique)		R=BSP thread (tapered)	
AD HP 40-1/8	TAD.4020.020	12	13.0	8.0	0.970
AD HP 40-1/4	TAD.4020.040	14	18.0	12.0	2.060
AD HP 40-3/8	TAD.4020.060	17	19.0	12.0	3.460
AD HP 40-1/2	TAD.4020.080	22	22.0	14.0	6.490
AD HP 40-3/4	TAD.4020.120	27	25.0	16.0	11.490
AD HP 40-1	TAD.4020.160	36	31.0	20.0	23.760

Verschlusschraube NPT

mit Aussen-6kt.

Bouchon fileté NPT

à six pans

Screw plug NPT

with hex-nut

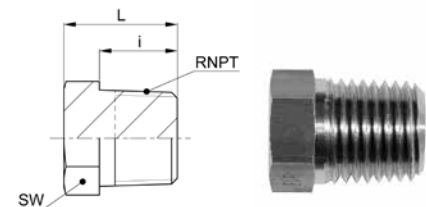

AD HP 40 NPT

Type -RNPT	Mat.-Nr.	SW	L	i	kg/100
RNPT=NPT Gewinde		RNPT=Filetage NPT		RNPT=NPT thread	
AD HP 40-1/8 NPT	TAD.4021.020	12	15.0	10.0	1.130
AD HP 40-1/4 NPT	TAD.4021.040	14	20.0	14.0	2.320
AD HP 40-3/8 NPT	TAD.4021.060	17	22.0	14.0	4.400
AD HP 40-1/2 NPT	TAD.4021.080	22	27.0	19.0	7.720
AD HP 40-3/4 NPT	TAD.4021.120	27	29.0	20.0	13.600

Verschlusschraube R

mit Innen-6kt.

Bouchon fileté R

avec six pans creux

Screw plug R

locked with Allen key

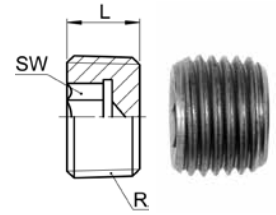

AD SP 40

Type -R	Mat.-Nr.	SW	L	kg/100
R=Rohrgewinde (kegelig)	R=Filetage-gaz BSP (conique)		R=BSP thread (tapered)	
AD SP 40-1/8	016.0711.020	5	8.0	0.340
AD SP 40-1/4	016.0711.040	7	10.0	0.750
AD SP 40-3/8	016.0711.060	8	10.0	1.320
AD SP 40-1/2	016.0711.080	10	10.0	1.940
AD SP 40-3/4	016.0711.120	12	12.0	4.110

Verschlusschraube G

mit Aussen-6kt.

Bouchon fileté G

à six pans

Screw plug G

with hex-nut

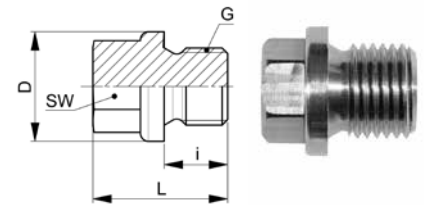

AD HPS 40

Type -G	Mat.-Nr.	SW	L	D	i	kg/100
G=Rohrgewinde (zylindrisch)	G=Filetage-gaz BSP (cylindrique)			G=BSP thread (parallel)		
AD HPS 40-1/8	TAD.4030.020	10	17.0	14.0	8.0	0.610
AD HPS 40-1/4	TAD.4030.040	13	21.0	18.0	12.0	1.430
AD HPS 40-3/8	TAD.4030.060	17	21.0	22.0	12.0	2.240
AD HPS 40-1/2	TAD.4030.080	19	26.0	26.0	14.0	4.250
AD HPS 40-3/4	TAD.4030.120	24	30.0	32.0	16.0	7.410

Einschraubgewinde nach DIN 3852-2 Form A.
Beim Einbau empfiehlt sich die Verwendung einer Dichtscheibe (z.B. SO 40007).
Die Dichtung muss bei Bedarf separat bestellt werden.

Filetage mâle selon DIN 3852-2 Forme A.
L'utilisation d'un joint (par exemple SO 40007) est recommandée pour l'installation.
Si nécessaire, le joint correspondant doit être commandé séparément.

Male adaptor thread according to DIN 3852-2 Form A.
The use of a sealing washer (e.g. SO 40007) is recommended for installation.
If required, the corresponding washer must be ordered separately.

Verschlusschraube G

mit Aussen-6kt. und Conovor O-Ringabdichtung (NBR)

Bouchon fileté G

à six pans, avec joint torique système Conovor (NBR)

Screw plug G

with hex-nut and Conovor O-ring seal (NBR)

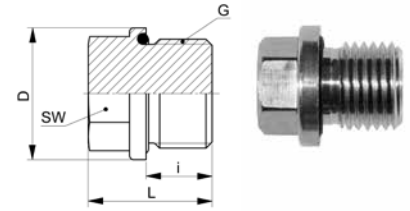

AD HPO 40

Type -G	Mat.-Nr.	SW	L	D	i	O-Ring	kg/100
G=Rohrgewinde (zylindrisch)		G=Filetage-gaz BSP (cylindrique)			G=BSP thread (parallel)		
AD HPO 40-1/8	TAD.4040.020	10	17.0	14.0	8.0	8.73x1.78	1.200
AD HPO 40-1/4	TAD.4040.040	13	21.0	18.0	12.0	11.1x1.78	2.460
AD HPO 40-3/8	TAD.4040.060	17	21.0	22.0	12.0	14.0x1.78	4.800
AD HPO 40-1/2	TAD.4040.080	19	26.0	26.0	14.0	18.72x2.62	7.180
AD HPO 40-3/4	TAD.4040.120	24	30.0	32.0	16.0	23.47x2.62	13.040

Verschlusschraube G

mit Innen-6kt.

Bouchon fileté G

avec six pans creux

Screw plug G

locked with Allen key

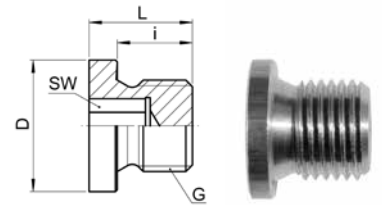

AD HSP 40

Type -G	Mat.-Nr.	SW	L	D	i	kg/100
G=Rohrgewinde (zylindrisch)		G=Filetage-gaz BSP (cylindrique)			G=BSP thread (parallel)	
AD HSP 40-1/8	TAD.4070.020	5	11.0	14.0	8.0	0.610
AD HSP 40-1/4	TAD.4070.040	6	15.0	18.0	12.0	1.430
AD HSP 40-3/8	TAD.4070.060	8	15.0	22.0	12.0	2.240
AD HSP 40-1/2	TAD.4070.080	10	18.0	26.0	14.0	4.250
AD HSP 40-3/4	TAD.4070.120	12	20.0	32.0	16.0	7.410
AD HSP 40-1	TAD.4070.160	17	21.0	39.0	16.0	11.000

Einschraubgewinde nach DIN 3852-2 Form A.
Beim Einbau empfiehlt sich die Verwendung einer Dichtscheibe (z.B. SO 40007).
Die Dichtung muss bei Bedarf separat bestellt werden.

Filetage mâle selon DIN 3852-2 Forme A.
L'utilisation d'un joint (par exemple SO 40007) est recommandée pour l'installation.
Si nécessaire, le joint correspondant doit être commandé séparément.

Male adaptor thread according to DIN 3852-2 Form A.
The use of a sealing washer (e.g. SO 40007) is recommended for installation.
If required, the corresponding washer must be ordered separately.

Verschlusschraube G

mit Innen-6kt. und Conovor O-Ringabdichtung (NBR)

Bouchon fileté G

avec six pans creux et joint torique système Conovor (NBR)

Screw plug G

locked with Allen key and Conovor O-ring seal (NBR)

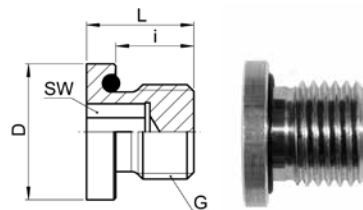

AD HSPO 40

Type -G	Mat.-Nr.	SW	L	D	i	O-Ring	kg/100
G=Rohrgewinde (zylindrisch)		G=Filetage-gaz BSP (cylindrique)			G=BSP thread (parallel)		
AD HSPO 40-1/8	TAD.4050.020	5	11.0	14.0	8.0	8.73x1.78	0.610
AD HSPO 40-1/4	TAD.4050.040	6	15.0	18.0	12.0	11.1x1.78	1.430
AD HSPO 40-3/8	TAD.4050.060	8	15.0	22.0	12.0	14.0x1.78	2.240
AD HSPO 40-1/2	TAD.4050.080	10	18.0	26.0	14.0	18.72x2.62	4.250
AD HSPO 40-3/4	TAD.4050.120	12	20.0	32.0	16.0	23.47x2.62	7.410

Aufschraub-Winkel G

Coude femelle G

Female threaded elbow G

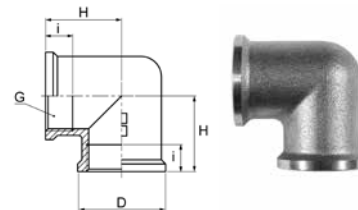

AD FE 40

Type -G	Mat.-Nr.	D	H	i	kg/100
G=Rohrgewinde (zylindrisch)		G=Filetage-gaz BSP (cylindrique)		G=BSP thread (parallel)	
AD FE 40-1/8-1/8	TAD.4300.042	15.0	15.0	8.0	2.000
AD FE 40-1/4-1/4	TAD.4300.104	20.0	19.0	10.0	4.380
AD FE 40-3/8-3/8	TAD.4300.166	23.0	23.0	11.0	5.930
AD FE 40-1/2-1/2	TAD.4300.228	30.0	25.0	12.0	7.430
AD FE 40-3/4-3/4	TAD.4300.292	36.0	30.0	15.0	12.090
AD FE 40-1-1	TAD.4300.414	42.0	35.0	16.0	21.100

Aufschraub-T G

Té femelle G

Female threaded tee G

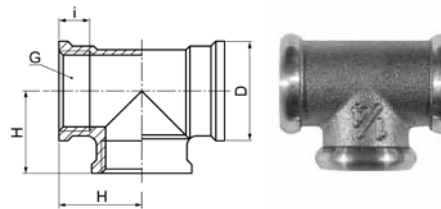

AD FT 40

Type -G	Mat.-Nr.	D	H	i	kg/100
G=Rohrgewinde (zylindrisch)		G=Filetage-gaz BSP (cylindrique)		G=BSP thread (parallel)	
AD FT 40-1/8-1/8-1/8	TAD.4400.060	15.0	14.0	8.0	2.610
AD FT 40-1/4-1/4-1/4	TAD.4400.160	21.0	17.5	10.0	5.680
AD FT 40-3/8-3/8-3/8	TAD.4400.350	23.0	21.5	11.0	9.360
AD FT 40-1/2-1/2-1/2	TAD.4400.450	30.0	24.0	12.0	9.700
AD FT 40-3/4-3/4-3/4	TAD.4400.520	36.0	30.0	15.0	16.760
AD FT 40-1-1-1	TAD.4400.650	42.0	34.0	16.0	25.850

Einschraubtülle R

Douille cannelée a visser R

Male adaptor hose nozzle R

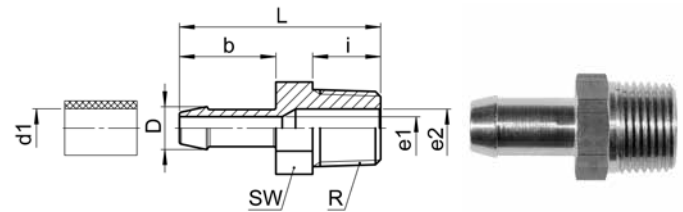

SO 40511

Type -d1 -R	Mat.-Nr.	SW	L	D	i	b	e1	e2	kg/100
R=Rohrgewinde (kegelig)	R=Filetage-gaz BSP (conique)	R=BSP thread (tapered)							
SO 40511-4-1/8	016.0511.060	10	23.0	5.0	8.0	11.0	3.0	6.0	0.750
SO 40511-6-1/8	016.0511.100	10	29.0	7.5	8.0	17.0	4.0	6.0	0.730
SO 40511-6-1/4	016.0511.110	14	34.5	7.5	12.0	17.0	4.0	8.5	1.920
SO 40511-8-1/8	016.0511.160	10	29.0	9.5	8.0	17.0	6.0	6.0	0.780
SO 40511-8-1/4	016.0511.170	14	34.5	9.5	12.0	17.0	6.0	8.5	1.690
SO 40511-8-3/8	016.0511.180	17	35.0	9.5	12.0	17.0	6.0	10.5	2.580
SO 40511-8-1/2	016.0511.185	22	40.0	9.5	16.0	17.0	6.0	13.0	4.530
SO 40511-10-1/8	016.0511.265	12	31.0	11.5	8.0	19.0	8.0	6.0	1.150
SO 40511-10-1/4	016.0511.270	14	36.5	11.5	12.0	19.0	8.0	8.0	1.640
SO 40511-10-3/8	016.0511.280	17	37.0	11.5	12.0	19.0	8.0	10.5	2.710
SO 40511-10-1/2	016.0511.285	22	42.0	11.5	16.0	19.0	8.0	13.0	4.900
SO 40511-13-3/8	016.0511.450	17	39.0	15.0	12.0	21.0	11.0	11.0	2.910
SO 40511-13-1/2	016.0511.454	22	44.0	15.0	16.0	21.0	11.0	13.0	5.340
SO 40511-16-1/2	016.0511.566	22	49.0	18.0	16.0	26.0	13.0	13.0	5.410
SO 40511-19-1/2	016.0511.676	22	49.0	21.5	16.0	26.0	16.0	13.0	5.800
SO 40511-19-3/4	016.0511.678	27	51.0	21.5	16.5	26.0	16.0	19.0	8.280

d1 = Schlauchinnendurchmesser

d1 = diamètre intérieur du tuyau

d1 = hose inside diameter

Einschraubtülle NPT

Douille cannelée à visser NPT

Male adaptor hose nozzle NPT

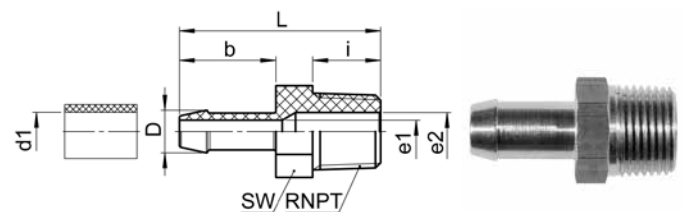

SO 40511 NPT

Type -d1 -RNPT	Mat.-Nr.	SW	L	D	i	b	e1	e2	kg/100
RNPT=NPT Gewinde	RNPT=Filetage NPT	RNPT=NPT thread							
SO 40511-6-1/4 NPT	016.0512.110	14	36.5	7.5	14.0	17.0	4.0	8.5	1.900
SO 40511-6-3/8 NPT	016.0512.120	17	37.0	7.5	14.0	17.0	4.0	10.5	2.870
SO 40511-8-1/8 NPT	016.0512.160	12	31.5	9.5	10.0	17.0	6.0	6.0	1.190

d1 = Schlauchinnendurchmesser

d1 = diamètre intérieur du tuyau

d1 = hose inside diameter

Übergangsmuffe G-G

Adaptateur femelle G - femelle G

Female adaptor G-G

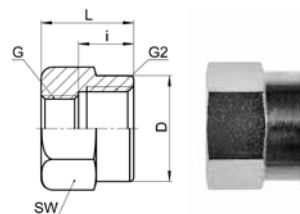

AD FA 80

Type -G -G2	Mat.-Nr.	SW	L	D	i	kg/100
G=Rohrgewinde (zylindrisch)		G=Filetage-gaz BSP (cylindrique)		G=BSP thread (parallel)		
G2=Rohrgewinde (zylindrisch)		G2=Filetage-gaz BSP (cylindrique)		G2=BSP thread (parallel)		
AD FA 80-1/8-1/8	036.0311.042	14	16.0	13.8	8.0	1.240
AD FA 80-1/8-1/4	036.0311.044	17	19.0	16.8	9.0	2.170
AD FA 80-1/4-1/4	036.0311.104	17	18.0	16.8	9.0	1.710
AD FA 80-1/4-3/8	036.0311.106	22	21.0	21.8	9.5	4.060
AD FA 80-1/4-1/2	036.0311.108	27	23.0	26.8	11.5	6.900
AD FA 80-3/8-3/8	036.0311.166	22	19.0	21.8	9.5	3.090
AD FA 80-3/8-1/2	036.0311.168	27	23.5	26.8	11.5	6.520
AD FA 80-1/2-1/2	036.0311.228	27	23.0	26.8	11.5	5.450
AD FA 80-3/4-1/2	036.0311.288	32	28.5	31.8	11.5	9.870

Übergangsnippel G-R

Adaptateur femelle G - mâle R

Adaptor female G - male R

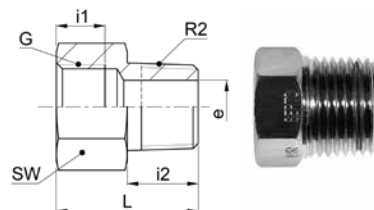

AD A 80 G-R

Type -G -R2	Mat.-Nr.	SW	L	i1	i2	e	kg/100
G=Rohrgewinde (zylindrisch)		G=Filetage-gaz BSP (cylindrique)		G=BSP thread (parallel)			
R2=Rohrgewinde (kegelig)		R2=Filetage-gaz BSP (conique)		R2=BSP thread (tapered)			
AD A 80-1/8-1/8	036.0411.042	14	21.0	8.0	8.0	5.0	2.100
AD A 80-1/8-1/4	036.0411.044	14	17.5	8.0	12.0	8.5	1.060
AD A 80-1/8-1/2	036.0411.048	22	23.0	9.6	16.0	14.0	3.970
AD A 80-1/4-1/8	036.0411.102	17	22.0	9.0	8.0	5.0	1.630
AD A 80-1/4-3/8	036.0411.106	17	20.0	9.0	12.0	11.4	1.690
AD A 80-1/4-1/2	036.0411.108	22	23.0	9.7	16.0	14.0	3.590
AD A 80-3/8-1/2	036.0411.168	22	23.0	9.5	16.0	14.9	2.740
AD A 80-1/2-3/4	036.0411.232	27	27.5	11.5	16.5	18.6	5.133

Übergangsnippel NPT-R

Adaptateur femelle NPT - mâle R

Adaptor female NPT - male R

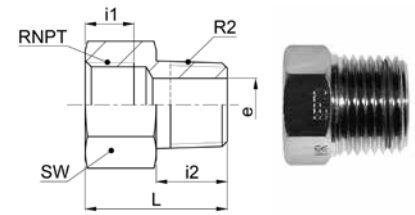

AD A 80 NPT-R

Type -RNPT -R2	Mat.-Nr.	SW	L	i1	i2	e	kg/100
RNPT=NPT Gewinde R2=Rohrgewinde (kegelig)	RNPT=Filetage NPT R2=Filetage-gaz BSP (conique)						
AD A 80-1/8 NPT-1/8	036.0414.042	14	21.0	10.0	8.0	6.0	1.470
AD A 80-1/8 NPT-1/4	036.0414.044	14	18.0	10.0	12.0	8.1	1.130
AD A 80-1/4 NPT-1/4	036.0414.104	17	29.0	14.0	12.0	8.5	2.740
AD A 80-1/4 NPT-3/8	036.0414.106	17	22.0	14.0	12.0	10.5	1.650
AD A 80-1/2 NPT-1/2	036.0414.228	27	38.0	18.0	16.0	14.0	8.310

Verschlusschraube R

mit Innen-6kt.

Bouchon fileté R

avec six pans creux

Screw plug R

locked with Allen key

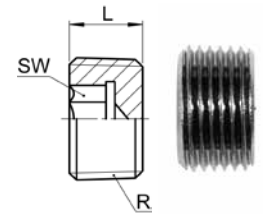

AD SP 80

Type -R	Mat.-Nr.	SW	L	kg/100
R=Rohrgewinde (kegelig)	R=Filetage-gaz BSP (conique)			
AD SP 80-1/8	036.0711.020	5	8.0	0.340
AD SP 80-1/4	036.0711.040	7	10.0	0.750
AD SP 80-3/8	036.0711.060	8	10.0	1.320
AD SP 80-1/2	036.0711.080	10	10.0	1.940

Einschraubtülle R

Douille cannelée à visser R

Male adaptor hose nozzle R

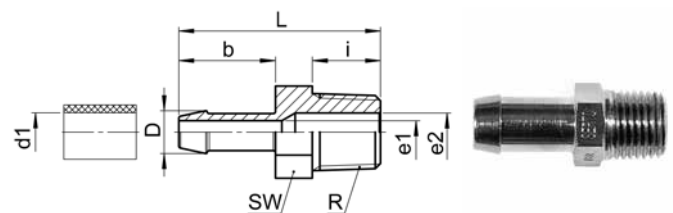

SO 80511

Type -d1 -R	Mat.-Nr.	SW	L	D	i	b	e1	e2	kg/100
R=Rohrgewinde (kegelig)	R=Filetage-gaz BSP (conique)								
SO 80511-6-1/8	036.0511.100	10	29.0	7.5	8.0	17.0	4.0	6.0	0.730
SO 80511-6-1/4	036.0511.110	14	34.5	7.5	12.0	17.0	4.0	8.5	1.920
SO 80511-8-1/4	036.0511.170	14	34.5	9.5	12.0	17.0	6.0	8.5	1.690
SO 80511-10-1/4	036.0511.270	14	36.5	11.5	12.0	19.0	8.0	8.0	1.640
SO 80511-13-3/8	036.0511.450	17	39.0	15.0	12.0	21.0	11.0	11.0	2.710

d1 = Schlauchinnendurchmesser

d1 = diamètre intérieur du tuyau

d1 = hose inside diameter

Doppelnippel G-G
Mamelon double G-G
Male threaded adaptor G-G

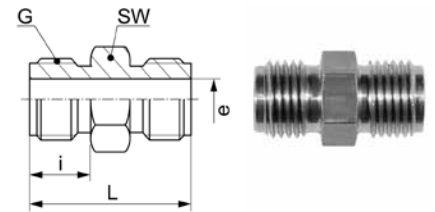

SO 01020

Type -G	Mat.-Nr.	bar	SW	L	i	e	kg/100
G=Rohrgewinde (zylindrisch)	G=Filetage-gaz BSP (cylindrique)		G=BSP thread (parallel)				
SO 01020-1/8-1/8	246.1020.060	125	12	26.0	10.0	4.5	1.420
SO 01020-1/4-1/4	246.1020.080	125	14	28.0	11.0	6.5	2.150
SO 01020-3/8-3/8	246.1020.100	100	17	30.0	11.5	8.5	3.800
SO 01020-1/2-1/2	246.1020.140	64	22	36.0	14.0	12.0	6.450

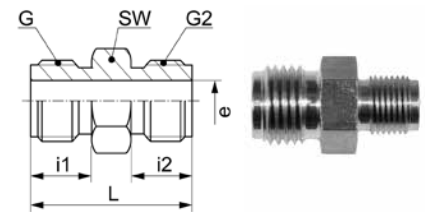
Doppelnippel G-G reduziert
Mamelon double G-G réduit
Reducing male threaded adaptor G-G

SO 01020 RED

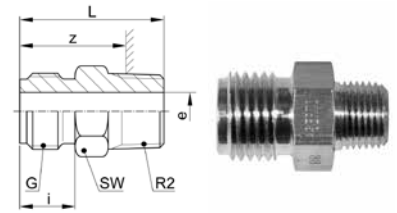
Type -G -G2	Mat.-Nr.	bar	SW	L	i1	i2	e	kg/100
G=Rohrgewinde (zylindrisch)	G=Filetage-gaz BSP (cylindrique)		G=BSP thread (parallel)					
G2=Rohrgewinde (zylindrisch)	G2=Filetage-gaz BSP (cylindrique)		G2=BSP thread (parallel)					
SO 01020-1/4-1/8	246.1024.140	125	14	27.0	11.0	10.0	4.5	2.100
SO 01020-3/8-1/4	246.1024.190	100	17	29.5	11.5	11.0	6.5	3.450
SO 01020-1/2-3/8	246.1024.240	64	22	33.5	14.0	11.5	8.5	6.200

Doppelnippel G-R
Mamelon double G-R
Male threaded adaptor G-R

SO 01100

Type -G-R2	Mat.-Nr.	bar	SW	L	i	z	e	kg/100
G=Rohrgewinde (zylindrisch)	G=Filetage-gaz BSP (cylindrique)		G=BSP thread (parallel)					
R2=Rohrgewinde (kegelig)	R2=Filetage-gaz BSP (conique)		R2=BSP thread (tapered)					
SO 01100-1/8 z-1/8 k	246.1101.100	125	10	22.0	10.0	18.0	4.0	1.310
SO 01100-1/8 z-1/4 k	246.1101.110	125	14	28.0	10.0	22.0	4.0	2.010
SO 01100-1/8 z-3/8 k	246.1101.120	125	17	28.0	10.0	21.6	4.0	2.810
SO 01100-1/4 z-1/8 k	246.1101.160	125	14	25.0	11.0	21.0	5.0	2.010
SO 01100-1/4 z-1/4 k	246.1101.170	125	14	29.0	11.0	23.0	6.5	2.410
SO 01100-1/4 z-3/8 k	246.1101.180	125	17	29.0	11.0	22.6	6.5	3.210
SO 01100-1/4 z-1/2 k	246.1101.185	125	22	34.0	11.0	25.8	6.5	4.910
SO 01100-3/8 z-1/4 k	246.1101.270	100	17	29.5	11.5	23.5	8.5	2.970
SO 01100-3/8 z-3/8 k	246.1101.280	100	17	29.5	11.5	23.1	8.5	3.570
SO 01100-3/8 z-1/2 k	246.1101.285	100	22	34.5	11.5	26.3	8.5	5.270
SO 01100-1/2 z-1/4 k	246.1101.380	64	22	33.0	14.0	27.0	8.0	5.970
SO 01100-1/2 z-3/8 k	246.1101.390	64	22	33.0	14.0	26.6	10.0	5.770
SO 01100-1/2 z-1/2 k	246.1101.504	64	22	37.0	14.0	28.8	12.0	6.260
SO 01100-1/2 z-3/4 k	246.1101.506	64	27	39.0	14.0	29.5	12.0	8.860
SO 01100-3/4 z-1/2 k	246.1101.596	64	27	40.0	15.0	31.8	14.0	9.190
SO 01100-3/4 z-3/4 k	246.1101.598	64	27	40.0	15.0	30.5	15.0	10.190

Doppelnippel G-G

mit Dichtkante

Mamelon double G-G

avec arête d'étanchéité

Male threaded adaptor G-G

with edge seal

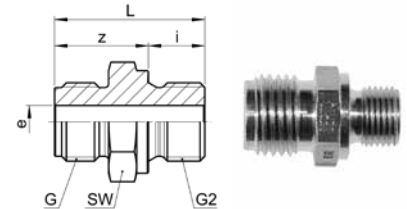

SO 01104

Type -G-G2	Mat.-Nr.	bar	SW	L	i	z	e	kg/100
G=Rohrgewinde (zylindrisch)	G=Filetage-gaz BSP (cylindrique)		G=BSP thread (parallel)					
G2=Rohrgewinde (zylindrisch)	G2=Filetage-gaz BSP (cylindrique)		G2=BSP thread (parallel)					
SO 01104-1/8-1/8	246.1141.100	125	14	23.5	8.0	15.5	4.0	1.410
SO 01104-1/8-1/4	246.1141.110	125	19	29.0	12.0	17.0	4.0	3.010
SO 01104-1/4-1/8	246.1141.160	125	14	24.5	8.0	16.5	5.0	1.710
SO 01104-1/4-1/4	246.1141.170	125	19	30.0	12.0	18.0	6.0	3.110
SO 01104-1/4-3/8	246.1141.180	125	22	31.5	12.0	19.5	6.0	4.010
SO 01104-3/8-1/4	246.1141.270	100	19	30.5	12.0	18.5	7.0	3.570
SO 01104-3/8-3/8	246.1141.280	100	22	32.0	12.0	20.0	7.0	5.470
SO 01104-1/2-1/4	246.1141.380	64	22	34.5	12.0	22.5	7.0	6.600
SO 01104-1/2-3/8	246.1141.390	64	22	34.5	12.0	22.5	9.0	6.270
SO 01104-1/2-1/2	246.1141.504	64	27	38.0	14.0	24.0	12.0	9.490

Übergangsnippel G-G

Adaptateur mâle G - femelle G

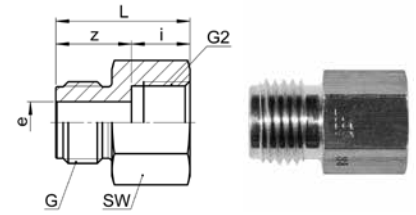
Adaptor male G - female G



SO 01200

Type -G-G2	Mat.-Nr.	bar	SW	L	i	z	e	kg/100
G=Rohrgewinde (zylindrisch)								
G2=Rohrgewinde (zylindrisch)								
G=Filetage-gaz BSP (cylindrique)								
G2=Filetage-gaz BSP (cylindrique)								
G=BSP thread (parallel)								
G2=BSP thread (parallel)								
SO 01200-1/8α-1/8i	246.1201.100	125	14	23.0	10.0	13.0	4.5	1.610
SO 01200-1/8α-1/4i	246.1201.110	125	17	25.0	11.0	14.0	4.5	2.310
SO 01200-1/8α-3/8i	246.1201.120	125	22	26.0	12.0	14.0	4.5	4.010
SO 01200-1/4α-1/8i	246.1201.160	125	14	24.0	10.0	14.0	6.5	2.010
SO 01200-1/4α-1/4i	246.1201.170	125	17	26.0	11.0	15.0	6.5	2.610
SO 01200-1/4α-3/8i	246.1201.180	125	22	27.0	12.0	15.0	6.5	4.010
SO 01200-1/4α-1/2i	246.1201.185	125	27	29.0	14.0	15.0	6.5	6.710
SO 01200-3/8α-1/4i	246.1201.270	100	17	26.5	11.0	15.5	8.5	2.970
SO 01200-3/8α-3/8i	246.1201.280	100	22	27.5	12.0	15.5	8.5	4.370
SO 01200-3/8α-1/2i	246.1201.285	100	27	30.0	14.0	16.0	8.5	6.970
SO 01200-3/8α-3/4i	246.1201.290	100	32	33.0	17.0	16.0	8.5	9.970
SO 01200-1/2α-3/8i	246.1201.390	64	22	30.0	12.0	18.0	10.5	5.370
SO 01200-1/2α-1/2i	246.1201.504	64	27	32.5	14.0	18.5	12.5	7.860
SO 01200-1/2α-3/4i	246.1201.506	64	32	35.5	17.0	18.5	12.5	11.060
SO 01200-3/4α-1/2i	246.1201.596	64	27	35.5	14.0	19.5	14.5	11.060
SO 01200-3/4α-3/4i	246.1201.598	64	32	36.5	17.0	19.5	15.5	11.060

Schott-Doppelnippel

Mamelon double traversée de cloison

Panel mount male threaded adaptor

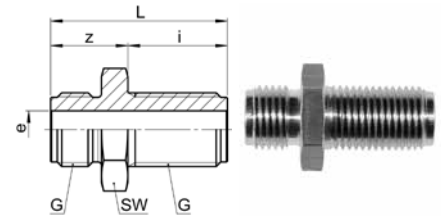

SO 01500

Type -G	Mat.-Nr.	bar	SW	L	i	z	e	kg/100
G=Rohrgewinde (zylindrisch)								
G=Filetage-gaz BSP (cylindrique)								
G=BSP thread (parallel)								
SO 01500-1/8-1/8	246.1500.060	125	14	35.0	20.0	15.0	4.0	1.900
SO 01500-1/4-1/4	246.1500.080	125	19	38.0	22.0	16.0	6.5	3.400
SO 01500-3/8-3/8	246.1500.100	100	24	40.0	22.5	17.5	8.5	6.100
SO 01500-1/2-1/2	246.1500.120	100	30	47.0	26.0	21.0	12.0	11.900

Schott-Doppelnippel lang

Mamelon double traversée de cloison long

Panel mount male threaded adaptor long

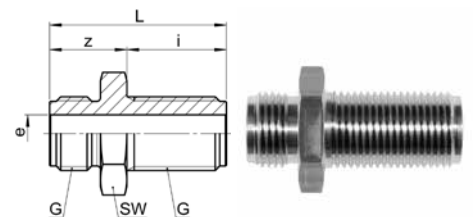

SO 01504

Type -G	Mat.-Nr.	bar	SW	L	i	z	e	kg/100
G=Rohrgewinde (zylindrisch)								
G=Filetage-gaz BSP (cylindrique)								
G=BSP thread (parallel)								
SO 01504-1/2-1/2	246.1540.140	100	30	58.0	37.0	21.0	12.0	11.800

Winkel G Coude G Elbow G

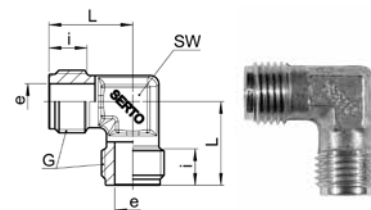

SO 02000

Type -G	Mat.-Nr.	bar	SW	L	i	e	kg/100
G=Rohrgewinde (zylindrisch)	G=Filetage-gaz BSP (cylindrique)		G=BSP thread (parallel)				
SO 02000-1/8-1/8	246.2000.060	125	10	19.0	8.5	4.0	1.620
SO 02000-1/4-1/4	246.2000.080	125	11	21.0	8.5	6.0	2.520
SO 02000-3/8-3/8	246.2000.100	100	14	22.0	9.5	8.5	3.740
SO 02000-1/2-1/2 (8+10+12)	246.2000.120	64	17	26.5	9.5	10.0	6.730
SO 02000-1/2-1/2 (14+15)	246.2000.140	64	19	28.0	12.5	12.0	6.640
SO 02000-3/4-3/4	246.2000.170	64	22	30.0	12.5	15.0	11.580

Winkel G-R Coude G-R Elbow G-R

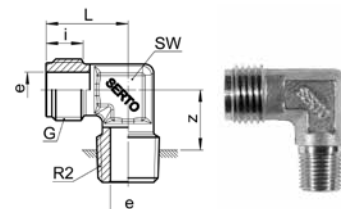

SO 02400

Type -G-R2	Mat.-Nr.	bar	SW	L	i	z	e	kg/100
G=Rohrgewinde (zylindrisch)	G=Filetage-gaz BSP (cylindrique)		G=BSP thread (parallel)					
R2=Rohrgewinde (kegelig)	R2=Filetage-gaz BSP (conique)		R2=BSP thread (tapered)					
SO 02400-1/8 z-1/8 k	246.2401.100	125	10	19.0	8.5	13.5	4.0	1.700
SO 02400-1/8 z-1/4 k	246.2401.110	125	11	21.0	8.5	15.0	4.0	2.600
SO 02400-1/4 z-1/8 k	246.2401.160	125	11	21.0	8.5	13.5	5.0	2.300
SO 02400-1/4 z-1/4 k	246.2401.170	125	11	21.0	8.5	15.0	6.0	2.800
SO 02400-1/4 z-3/8 k	246.2401.180	125	14	22.0	8.5	16.0	6.0	4.200
SO 02400-3/8 z-1/4 k	246.2401.270	100	14	22.0	9.5	15.0	8.5	3.700
SO 02400-3/8 z-3/8 k	246.2401.280	100	14	22.0	9.5	16.0	8.5	4.300
SO 02400-3/8 z-1/2 k	246.2401.285	100	19	28.0	10.0	19.0	8.0	6.700
SO 02400-1/2 z-1/4 k	246.2401.380	64	17	25.0	11.5	16.0	7.0	5.900
SO 02400-1/2 z-3/8 k	246.2401.390	64	17	25.0	11.5	16.0	10.0	5.900
SO 02400-1/2 z-1/2 k	246.2401.504	64	19	28.0	13.0	19.0	12.0	7.900
SO 02400-1/2 z-3/4 k	246.2401.506	64	22	30.0	13.0	20.0	12.0	8.300
SO 02400-3/4 z-1/2 k	246.2401.596	64	22	30.0	12.0	19.0	14.0	10.600
SO 02400-3/4 z-3/4 k	246.2401.598	64	22	30.0	12.0	20.0	15.0	12.700

Winkel G-NPT

Coude G-NPT

Elbow G-NPT

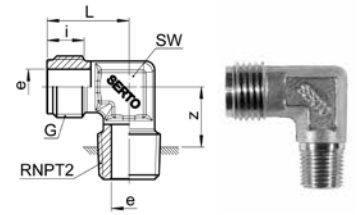

SO 02400 NPT

Type -G -RNPT2	Mat.-Nr.	bar	SW	L	i	z	e	kg/100
G=Rohrgewinde (zylindrisch)	G=Filetage-gaz BSP (cylindrique)				G=BSP thread (parallel)			
RNPT2=NPT Gewinde	RNPT2=Filetage NPT				RNPT2=NPT thread			
SO 02400-1/8 z-3/8 NPT	246.2402.120	125	14	21.0	8.5	16.0	4.0	3.900
SO 02400-1/4 z-3/8 NPT	246.2402.180	125	14	22.0	9.5	16.0	6.0	4.200

T-Stück G

Pièce Té G

T-piece G

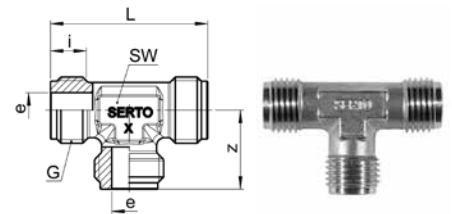

SO 03000

Type -G	Mat.-Nr.	bar	SW	L	i	z	e	kg/100
G=Rohrgewinde (zylindrisch)	G=Filetage-gaz BSP (cylindrique)				G=BSP thread (parallel)			
SO 03000-1/8-1/8-1/8	246.3000.060	125	10	38.0	8.5	19.0	4.0	2.200
SO 03000-1/4-1/4-1/4	246.3000.080	125	11	42.0	9.0	21.0	6.0	3.600
SO 03000-3/8-3/8-3/8	246.3000.100	100	14	44.0	9.5	22.0	8.0	5.200
SO 03000-1/2-1/2-1/2	246.3000.120	100	19	50.0	11.0	25.0	11.0	9.300
SO 03000-3/4-3/4-3/4	246.3000.170	64	27	64.0	13.0	32.0	15.0	15.700

Adapter Edelstahl

Adaptateurs inox

Adaptors stainless steel

Eigenschaften, Besonderheiten

- einfache Verbindungselemente mit Innen- und Aussengewinden, Tüllen und Abschlusselementen
- zahlreiche Bauformen
- viele Kombinationsmöglichkeiten

Betriebsdruck

niedrige bis mittlere Drücke

Werkstoff

- Typ 50 = 1.4571 (~ AISI 316 Ti)
- Typ 51 = 1.4401 (AISI 316)

Herstellung

- gerade Verbinder: gefertigt aus Vollmaterial
- Winkel und T-Stücke: Druckguss

Gewinde

G = Rohrgewinde BSP (zylindrisch) ISO 228
 R = Rohrgewinde (kegelig) EN 10226-1
 NPT = Rohrgewinde (kegelig) ANSI B 1.20.1

Bestätigungen

FDA für FKM-O-Ringe

Propriétés, spécificités

- éléments simples d'assemblage avec des filetages intérieurs et extérieurs, des douilles et des éléments de fermeture
- grand nombre de formes de construction
- nombreuses possibilités de combinaison

Pression de service

pression faible à moyenne

Matériaux

- type 50 = 1.4571 (~ AISI 316 Ti)
- type 51 = 1.4401 (AISI 316)

Fabrication

- connecteurs droits: fabriqués de matériel plein
- coudes et Tés: moulage sous pression

Filetages

G = filetage gas BSP (cylindrique) ISO 228
 R = filetage gas BSP (conique) EN 10226-1
 NPT = filetage NPT (conique) ANSI B 1.20.1

Confirmations

FDA pour les joints toriques FKM

Characteristics, specialities

- simple connecting pieces with internal and external threads, hose nozzles and end elements
- large number of design types
- many possible combinations

Working pressure

low to medium pressure

Materials

- type 50 = 1.4571 (~ AISI 316 Ti)
- type 51 = 1.4401 (AISI 316)

Manufacture

- straight connectors: made of solid material
- elbows and Tees: die casting

Threads

G = BSP pipe thread (straight) ISO 228
 R = BSP pipe thread (tapered) EN 10226-1
 NPT = NPT pipe thread (tapered) ANSI B 1.20.1

Confirmations

FDA for FKM O-rings

Doppelnippel R-R

Mamelon double R-R

Male threaded adaptor R-R

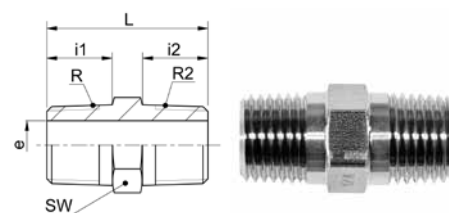

AD HN 50 R

Type -R-R2	Mat.-Nr.	bar	SW	L	i1	i2	e	kg/100
R=Rohrgewinde (kegelig)	R=Filetage-gaz BSP (conique)				R=BSP thread (tapered)			
R2=Rohrgewinde (kegelig)	R2=Filetage-gaz BSP (conique)				R2=BSP thread (tapered)			
AD HN 50-1/8-1/8	TAD.5110.042	400	12	25.0	9.5	9.5	6.0	1.050
AD HN 50-1/8-1/4	TAD.5110.044	400	14	28.0	9.5	12.5	6.0	1.910
AD HN 50-1/8-3/8	TAD.5110.046	400	17	30.0	9.5	12.5	6.0	3.340
AD HN 50-1/8-1/2	TAD.5110.048	400	22	35.0	9.5	17.5	6.0	6.640
AD HN 50-1/4-1/4	TAD.5110.104	400	14	31.0	12.5	12.5	8.0	2.070
AD HN 50-1/4-3/8	TAD.5110.106	400	17	33.0	12.5	12.5	8.0	3.460
AD HN 50-1/4-1/2	TAD.5110.108	400	22	38.0	12.5	17.5	8.0	6.680
AD HN 50-3/8-3/8	TAD.5110.166	400	17	33.0	12.5	12.5	10.5	3.330
AD HN 50-3/8-1/2	TAD.5110.168	400	22	38.0	12.5	17.5	10.5	6.390
AD HN 50-1/2-1/2	TAD.5110.228	400	22	43.0	17.5	17.5	13.0	7.060
AD HN 50-1/2-3/4	TAD.5110.232	200	27	46.5	17.5	19.0	13.0	12.090
AD HN 50-1/2-1	TAD.5110.236	100	36	48.5	17.5	21.0	13.0	21.120
AD HN 50-3/4-3/4	TAD.5110.292	200	27	48.0	19.0	19.0	21.0	7.620
AD HN 50-3/4-1	TAD.5110.296	100	36	50.0	19.0	21.0	21.0	16.340
AD HN 50-1-1	TAD.5110.414	100	36	52.0	21.0	21.0	26.0	14.470

Doppelnippel R-NPT

Mamelon double R-NPT

Male threaded adaptor R-NPT

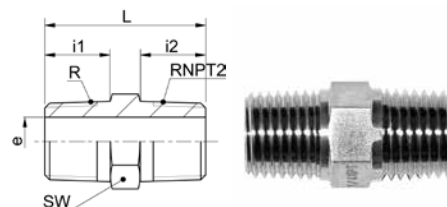

AD HN 50 R-NPT

Type -R-RNPT2	Mat.-Nr.	bar	SW	L	i1	i2	e	kg/100
R=Rohrgewinde (kegelig)	R=Filetage-gaz BSP (conique)				R=BSP thread (tapered)			
RNPT2=NPT Gewinde	RNPT2=Filetage NPT				RNPT2=NPT thread			
AD HN 50-1/8-1/8 NPT	TAD.5114.042	400	12	25.0	9.5	9.5	6.0	1.060
AD HN 50-1/4-1/4 NPT	TAD.5114.104	400	14	31.0	12.5	12.5	8.0	2.060
AD HN 50-3/8-3/8 NPT	TAD.5114.166	330	17	33.0	12.5	12.5	10.5	3.260
AD HN 50-1/2-1/2 NPT	TAD.5114.228	330	22	43.0	17.5	17.5	13.0	6.850
AD HN 50-3/4-3/4 NPT	TAD.5114.292	200	27	48.0	19.0	19.0	21.0	7.370
AD HN 50-1-1 NPT	TAD.5114.414	200	36	52.0	21.0	21.0	26.0	13.760

Doppelnippel NPT-NPT

Mamelon double NPT-NPT

Male threaded adaptor NPT-NPT

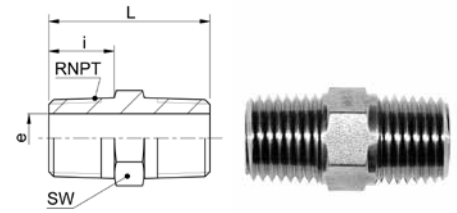

AD HN 50 NPT-NPT

Type -RNPT	Mat.-Nr.	bar	SW	L	i	e	kg/100
RNPT=NPT Gewinde	RNPT=Filetage NPT				RNPT=NPT thread		
AD HN 50-1/8 NPT-1/8 NPT	TAD.5111.042	400	12	25.0	9.5	6.0	1.110
AD HN 50-1/4 NPT-1/4 NPT	TAD.5111.104	400	14	31.0	12.5	8.0	2.140
AD HN 50-3/8 NPT-3/8 NPT	TAD.5111.166	330	17	33.0	12.5	10.5	3.340
AD HN 50-1/2 NPT-1/2 NPT	TAD.5111.228	330	22	43.0	17.5	13.0	6.940
AD HN 50-3/4 NPT-3/4 NPT	TAD.5111.292	330	27	48.0	19.0	21.0	7.450
AD HN 50-1 NPT-1 NPT	TAD.5111.414	200	36	52.0	21.0	26.0	13.690

Doppelnippel G-G

60°-Innenkonus

Mamelon double G-G

cône intérieur 60°

Male threaded adaptor G-G

60° inner cone

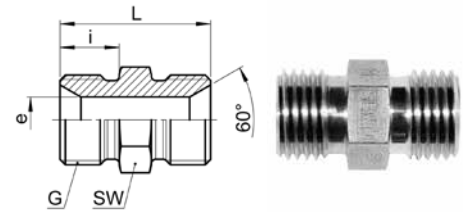

ADH HNC 50

Type -G	Mat.-Nr.	bar	SW	L	i	e	kg/100
G=Rohrgewinde (zylindrisch)	G=Filetage-gaz BSP (cylindrique)				G=BSP thread (parallel)		
ADH HNC 50-1/4 -1/4	496.5100.104	400	14	26.0	10.0	7.5	1.490
ADH HNC 50-3/8 -3/8	496.5100.166	400	17	28.0	11.0	8.5	2.560

Doppelnippel G-R

60° Innenkonus / kegeliges Aussengewinde

Mamelon double G-R

cône intérieur 60° / filetage conique

Male threaded adaptor G-R

60° inner cone / tapered male thread

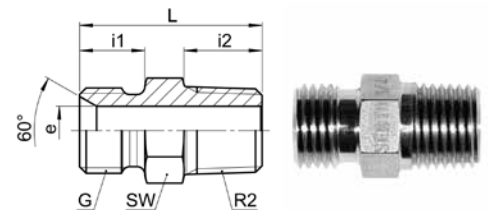

ADH HNIC 50

Type -G -R2	Mat.-Nr.	bar	SW	L	i1	i2	e	kg/100
G=Rohrgewinde (zylindrisch)	G=Filetage-gaz BSP (cylindrique)				G=BSP thread (parallel)			
R2=Rohrgewinde (kegelig)	R2=Filetage-gaz BSP (conique)				R2=BSP thread (tapered)			
ADH HNIC 50-1/8 -1/8	496.5210.042	400	10	22.0	9.0	8.0	4.0	0.760
ADH HNIC 50-1/4 -1/4	496.5210.104	400	14	28.0	11.0	12.0	7.5	1.120
ADH HNIC 50-3/8 -3/8	496.5210.166	400	17	30.0	11.5	12.0	10.0	3.280
ADH HNIC 50-1/2 -1/2	496.5210.228	400	22	34.0	12.0	14.0	12.0	5.480
ADH HNIC 50-3/4 -3/4	496.5210.292	200	27	38.0	13.0	16.0	17.0	9.000

Sechskantnippel G-G

60° Innenkonus / Innengewinde

Adaptateur hexagonal G-G

cône intérieur 60° / taraudage

Hexagonal nipple G-G

60° inner cone / female thread

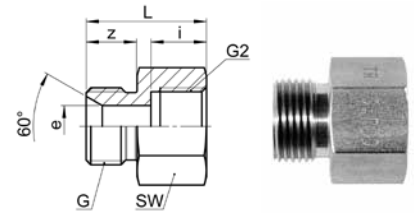

ADH A 50

Type -G -G2	Mat.-Nr.	bar	SW	L	i	z	e	kg/100
G=Rohrgewinde (zylindrisch)								
G2=Rohrgewinde (zylindrisch)								
ADH A 50- $\frac{3}{8}$ - $\frac{3}{8}$	496.5320.166	200	22	26.0	12.0	11.0	9.0	3.870
ADH A 50- $\frac{1}{2}$ - $\frac{1}{2}$	496.5320.228	200	27	29.0	14.0	12.0	12.0	6.110

Rohrdoppelnippel R

Mamelon double tubulaire R

Tube double threaded nipple R

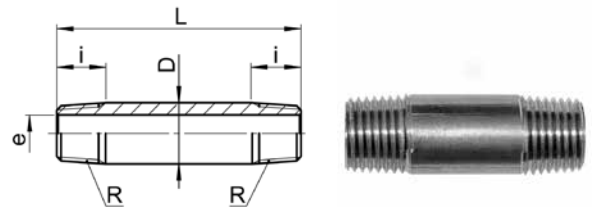

AD CN 50

Type -R xL	Mat.-Nr.	bar	L	D	i	e	kg/100
R=Rohrgewinde (kegelig)							
R=Filetage-gaz BSP (conique)							
R=BSP thread (tapered)							
AD CN 50- $\frac{1}{8}$ x40	TAD.5150.021	400	40.0	10.0	8.0	6.0	1.400
AD CN 50- $\frac{1}{8}$ x60	TAD.5150.023	400	60.0	10.0	8.0	7.5	2.200
AD CN 50- $\frac{1}{4}$ x40	TAD.5150.042	400	40.0	14.0	9.0	9.0	2.400
AD CN 50- $\frac{1}{4}$ x60	TAD.5150.045	400	60.0	14.0	9.0	9.0	2.860
AD CN 50- $\frac{1}{4}$ x80	TAD.5150.049	400	80.0	14.0	9.0	9.0	5.700
AD CN 50- $\frac{1}{4}$ x100	TAD.5150.053	400	100.0	14.0	9.0	9.0	7.100
AD CN 50- $\frac{1}{4}$ x150	TAD.5150.058	400	150.0	14.0	9.0	9.0	8.000
AD CN 50- $\frac{3}{8}$ x60	TAD.5150.060	400	60.0	17.0	12.0	12.0	4.000
AD CN 50- $\frac{1}{2}$ x40	TAD.5150.082	400	40.0	21.0	13.0	16.0	3.600
AD CN 50- $\frac{1}{2}$ x60	TAD.5150.084	400	60.0	21.0	13.0	16.0	5.970
AD CN 50- $\frac{1}{2}$ x80	TAD.5150.086	400	80.0	21.0	13.0	16.0	8.100
AD CN 50- $\frac{1}{2}$ x100	TAD.5150.088	400	100.0	21.0	13.0	16.0	11.050
AD CN 50- $\frac{1}{2}$ x150	TAD.5150.093	400	150.0	21.0	13.0	16.0	15.900
AD CN 50- $\frac{3}{4}$ x80	TAD.5150.126	200	80.0	27.0	17.0	22.0	10.850
AD CN 50- $\frac{3}{4}$ x100	TAD.5150.128	200	100.0	27.0	17.0	20.0	12.800
AD CN 50- $\frac{3}{4}$ x150	TAD.5150.134	200	150.0	27.0	17.0	22.0	20.300
AD CN 50-1 x60	TAD.5150.162	100	60.0	34.0	17.0	28.0	11.600
AD CN 50-1 x80	TAD.5150.164	100	80.0	34.0	17.0	28.0	13.300
AD CN 50-1 x100	TAD.5150.166	100	100.0	34.0	17.0	28.0	14.900
AD CN 50-1 x150	TAD.5150.171	100	150.0	34.0	17.0	28.0	32.200
AD CN 50-1 x180	TAD.5150.174	100	180.0	34.0	17.0	28.0	38.600
AD CN 50-1 x200	TAD.5150.176	100	200.0	34.0	17.0	28.0	43.700

Rohrnippel G

Mamelon tubulaire G

Tube nipple G

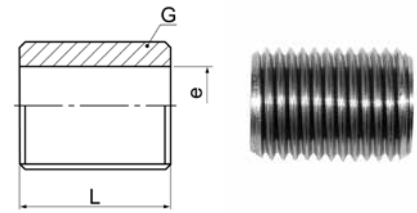

AD CNS 50

Type -G	Mat.-Nr.	bar	L	e	kg/100
G=Rohrgewinde (zylindrisch)	G=Filetage-gaz BSP (cylindrique)			G=BSP thread (parallel)	
AD CNS 50-1/4	TAD.5180.104	400	18.0	9.0	0.600
AD CNS 50-3/8	TAD.5180.166	400	22.0	12.0	1.070
AD CNS 50-1/2	TAD.5180.228	400	25.0	16.0	1.440
AD CNS 50-3/4	TAD.5180.292	200	30.0	22.0	2.650

Rohranschweissnippel R

Embout fileté à souder R

Weld-on nipple R

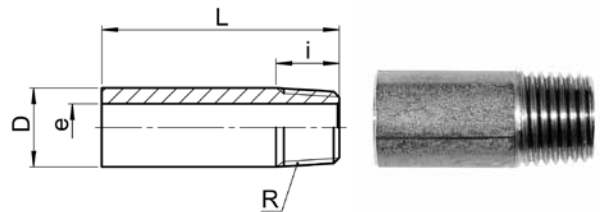

AD CNW 50

Type -R	Mat.-Nr.	bar	L	D	i	e	kg/100
R=Rohrgewinde (kegelig)	R=Filetage-gaz BSP (conique)					R=BSP thread (tapered)	
AD CNW 50-1/8	TAD.5170.020	400	30.0	10.0	8.0	6.0	0.900
AD CNW 50-1/4	TAD.5170.040	400	30.0	13.5	9.0	9.0	1.100
AD CNW 50-3/8	TAD.5170.060	400	30.0	17.0	12.0	12.0	1.760
AD CNW 50-1/2	TAD.5170.080	400	35.0	21.0	13.0	16.5	3.600
AD CNW 50-3/4	TAD.5170.120	200	40.0	27.0	15.0	21.5	5.200
AD CNW 50-1	TAD.5170.160	100	40.0	34.0	17.0	28.0	5.250

Rohranschweissnippel NPT

Embout fileté à souder NPT

Weld-on nipple NPT

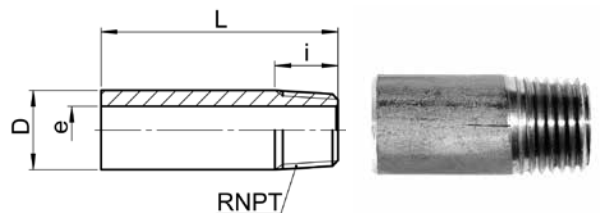

AD CNW 50 NPT

Type -RNPT	Mat.-Nr.	bar	L	D	i	e	kg/100
RNPT=NPT Gewinde	RNPT=Filetage NPT					RNPT=NPT thread	
AD CNW 50-1/8 NPT	TAD.5171.020	400	30.0	10.0	8.5	6.0	0.720
AD CNW 50-1/4 NPT	TAD.5171.040	400	30.0	13.5	12.5	8.8	1.140
AD CNW 50-3/8 NPT	TAD.5171.060	330	30.0	17.0	12.0	12.0	2.100
AD CNW 50-1/2 NPT	TAD.5171.080	330	35.0	21.0	13.0	16.5	2.400
AD CNW 50-3/4 NPT	TAD.5171.120	330	40.0	27.0	17.5	22.0	3.320
AD CNW 50-1 NPT	TAD.5171.160	200	40.0	33.5	21.0	27.5	5.010

Übergangsnippel G-R

Adaptateur femelle G - mâle R

Adaptor female G - male R

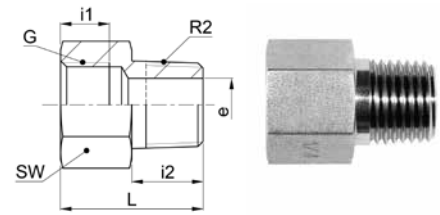

AD A 50 G-R

Type -G-R2	Mat.-Nr.	bar	SW	L	i1	i2	e	kg/100
G=Rohrgewinde (zylindrisch)	G=Filetage-gaz BSP (cylindrique)		G=BSP thread (parallel)					
R2=Rohrgewinde (kegelig)	R2=Filetage-gaz BSP (conique)		R2=BSP thread (tapered)					
AD A 50-1/8-1/8	TAD.5120.042	400	14	21.0	8.0	9.5	6.0	1.230
AD A 50-1/8-1/4	TAD.5130.044	400	14	18.5	8.0	12.0	8.7	1.140
AD A 50-1/8-3/8	TAD.5130.046	400	17	20.5	8.0	12.0	8.7	2.460
AD A 50-1/8-1/2	TAD.5130.048	400	22	25.5	8.0	14.0	8.7	5.510
AD A 50-1/4-1/8	TAD.5120.102	400	17	23.0	9.0	9.5	6.0	1.780
AD A 50-1/4-1/4	TAD.5120.104	400	17	26.0	9.0	12.5	8.0	2.200
AD A 50-1/4-3/8	TAD.5130.106	400	17	20.5	9.0	12.0	11.6	1.800
AD A 50-1/4-1/2	TAD.5130.108	400	22	25.5	9.0	14.0	11.6	4.700
AD A 50-1/4-3/4	TAD.5130.110	400	27	29.0	9.0	16.0	11.6	9.580
AD A 50-3/8-1/4	TAD.5120.164	400	22	28.0	9.5	12.5	8.0	3.590
AD A 50-3/8-3/8	TAD.5120.166	400	22	27.0	9.5	12.5	10.5	3.700
AD A 50-3/8-1/2	TAD.5130.168	400	22	25.5	9.5	14.0	15.2	3.940
AD A 50-3/8-3/4	TAD.5130.170	160	27	29.0	9.5	16.0	15.2	7.650
AD A 50-3/8-1	TAD.5130.172	100	36	31.0	9.5	18.0	15.2	16.640
AD A 50-1/2-1/4	TAD.5120.224	400	27	31.0	11.5	12.5	8.0	5.820
AD A 50-1/2-3/8	TAD.5120.226	400	27	30.0	11.5	12.5	10.5	5.790
AD A 50-1/2-1/2	TAD.5120.228	400	27	35.0	11.5	17.5	13.0	7.190
AD A 50-1/2-3/4	TAD.5130.232	160	27	29.0	11.5	16.0	19.0	6.080
AD A 50-1/2-1	TAD.5130.236	100	36	31.0	14.0	20.0	19.0	14.500
AD A 50-3/4-1/2	TAD.5120.288	200	32	39.0	14.0	17.5	13.0	9.670
AD A 50-3/4-3/4	TAD.5120.292	160	32	40.0	14.0	19.0	21.0	9.170
AD A 50-3/4-1	TAD.5130.296	100	36	31.0	14.0	18.0	24.5	10.490
AD A 50-1-1/2	TAD.5120.408	200	41	45.0	17.0	17.5	13.0	18.790
AD A 50-1-3/4	TAD.5120.412	160	41	45.0	17.0	19.0	21.0	17.130
AD A 50-1-1	TAD.5120.414	100	41	45.0	17.0	21.0	26.0	17.530

Übergangsnippel G-NPT

Adaptateur femelle G - mâle NPT

Adaptor female G - male NPT

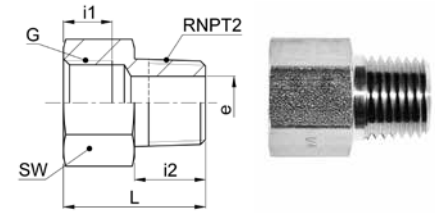

AD A 50 G-NPT

Type -G -RNPT2	Mat.-Nr.	bar	SW	L	i1	i2	e	kg/100
G=Rohrgewinde (zylindrisch)	G=Filetage-gaz BSP (cylindrique)				G=BSP thread (parallel)			
RNPT2=NPT Gewinde	RNPT2=Filetage NPT				RNPT2=NPT thread			
AD A 50-1/8-1/8 NPT	TAD.5124.042	400	14	21.0	8.0	9.5	6.0	1.280
AD A 50-1/8-1/4 NPT	TAD.5134.044	400	14	18.5	8.0	12.5	8.7	1.220
AD A 50-1/8-3/8 NPT	TAD.5134.046	400	17	20.5	8.0	12.5	8.7	2.670
AD A 50-1/8-1/2 NPT	TAD.5134.048	400	22	25.5	8.0	17.5	8.7	5.900
AD A 50-1/4-1/8 NPT	TAD.5124.102	400	17	23.0	9.0	9.5	6.0	1.830
AD A 50-1/4-1/4 NPT	TAD.5124.104	400	17	26.0	9.0	12.5	8.0	2.280
AD A 50-1/4-3/8 NPT	TAD.5134.106	400	17	20.5	9.0	12.5	11.6	1.880
AD A 50-1/4-1/2 NPT	TAD.5134.108	400	22	25.5	9.0	17.5	11.6	5.050
AD A 50-1/4-3/4 NPT	TAD.5134.110	400	27	29.0	9.0	19.0	11.6	10.200
AD A 50-3/8-1/4 NPT	TAD.5124.164	400	22	28.0	9.5	12.5	8.0	3.670
AD A 50-3/8-3/8 NPT	TAD.5124.166	400	22	27.0	9.5	12.5	10.5	3.790
AD A 50-3/8-1/2 NPT	TAD.5134.168	400	22	25.5	9.5	17.5	15.2	3.490
AD A 50-1/2-1/4 NPT	TAD.5124.224	400	27	31.0	11.5	12.5	8.0	6.150
AD A 50-1/2-3/8 NPT	TAD.5124.226	400	27	30.0	11.5	12.5	10.5	6.130
AD A 50-1/2-1/2 NPT	TAD.5124.228	400	27	35.0	11.5	17.5	13.0	7.280
AD A 50-1/2-3/4 NPT	TAD.5134.232	400	27	29.0	11.5	19.0	19.0	6.170
AD A 50-3/4-1/2 NPT	TAD.5124.288	200	32	39.0	14.0	17.5	13.0	10.180
AD A 50-3/4-3/4 NPT	TAD.5124.292	200	32	40.0	14.0	19.0	21.0	9.650
AD A 50-3/4-1 NPT	TAD.5134.296	200	36	31.0	14.0	21.0	24.5	10.780
AD A 50-1-3/4 NPT	TAD.5124.412	200	41	45.0	17.0	19.0	21.0	18.180
AD A 50-1-1 NPT	TAD.5124.414	200	41	45.0	17.0	21.0	26.0	18.470

Übergangsnippel NPT-R

Adaptateur femelle NPT - mâle R

Adaptor female NPT - male R

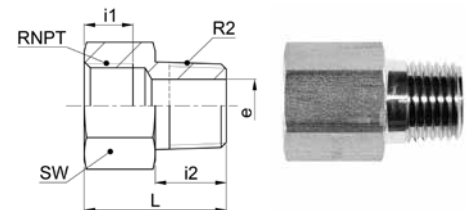

AD A 50 NPT-R

Type -RNPT -R2	Mat.-Nr.	bar	SW	L	i1	i2	e	kg/100
RNPT=NPT Gewinde	RNPT=Filetage NPT				RNPT=NPT thread			
R2=Rohrgewinde (kegelig)	R2=Filetage-gaz BSP (conique)				R2=BSP thread (tapered)			
AD A 50-1/8 NPT-1/8	TAD.5125.042	400	14	21.0	6.7	9.5	6.0	1.240
AD A 50-1/8 NPT-1/4	TAD.5135.044	400	14	18.5	6.7	12.5	8.4	1.150
AD A 50-1/4 NPT-1/4	TAD.5125.104	400	17	29.0	10.2	12.5	8.0	2.430
AD A 50-1/4 NPT-3/8	TAD.5135.106	400	17	20.5	10.2	12.5	10.8	1.870
AD A 50-1/4 NPT-1/2	TAD.5135.108	400	22	25.5	10.2	17.5	10.8	5.110
AD A 50-3/8 NPT-3/8	TAD.5125.166	400	22	29.0	10.3	12.5	10.5	4.050
AD A 50-1/2 NPT-1/2	TAD.5125.228	400	27	38.0	13.5	17.5	13.0	8.600
AD A 50-1/2 NPT-3/4	TAD.5135.232	160	27	29.0	13.5	19.0	17.7	6.830
AD A 50-3/4 NPT-3/4	TAD.5125.292	160	32	43.0	13.8	19.0	21.0	11.000
AD A 50-1 NPT-1	TAD.5125.414	160	36	45.0	17.4	21.0	26.0	12.830

Übergangsnippel NPT-NPT

Adaptateur femelle NPT - mâle NPT

Adaptor female NPT - male NPT

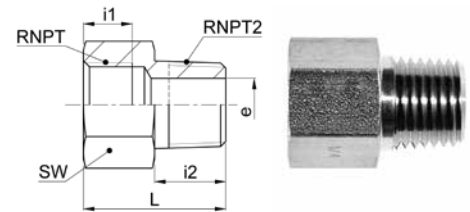

AD A 50 NPT-NPT

Type -RNPT -RNPT2	Mat.-Nr.	bar	SW	L	i1	i2	e	kg/100
RNPT=NPT Gewinde	RNPT=Filetage NPT				RNPT=NPT thread			
RNPT2=NPT Gewinde	RNPT2=Filetage NPT				RNPT2=NPT thread			
AD A 50-1/8 NPT -1/4 NPT	TAD.5131.044	400	14	18.5	6.7	12.5	8.4	1.280
AD A 50-1/8 NPT -3/8 NPT	TAD.5131.046	400	17	20.5	6.7	12.5	8.4	2.660
AD A 50-1/4 NPT -1/8 NPT	TAD.5121.102	400	17	26.0	10.2	9.5	6.0	2.150
AD A 50-1/4 NPT -3/8 NPT	TAD.5131.106	400	17	20.5	10.2	12.5	10.8	2.070
AD A 50-1/4 NPT -1/2 NPT	TAD.5131.108	400	22	25.5	10.2	17.5	10.8	5.150
AD A 50-3/8 NPT -1/4 NPT	TAD.5121.164	400	22	30.0	10.3	12.5	8.0	3.920
AD A 50-3/8 NPT -1/2 NPT	TAD.5131.168	400	22	25.5	10.3	17.5	13.9	3.980
AD A 50-1/2 NPT -1/4 NPT	TAD.5121.224	400	27	35.0	13.5	12.5	8.0	7.510
AD A 50-1/2 NPT -3/8 NPT	TAD.5121.226	400	27	35.0	13.5	12.5	10.5	8.030
AD A 50-1/2 NPT -3/4 NPT	TAD.5131.232	400	27	29.0	13.5	19.0	17.7	6.820
AD A 50-1/2 NPT -1 NPT	TAD.5131.236	200	36	31.0	13.5	21.0	17.7	15.880
AD A 50-3/4 NPT -1/2 NPT	TAD.5121.288	400	32	43.0	13.8	17.5	13.0	12.030
AD A 50-3/4 NPT -1 NPT	TAD.5131.296	200	36	31.0	13.8	21.0	22.5	11.920
AD A 50-1 NPT -1/2 NPT	TAD.5121.408	200	36	48.0	17.4	17.5	13.0	14.540
AD A 50-1 NPT -3/4 NPT	TAD.5121.412	200	36	48.0	17.4	19.0	21.0	13.110

Muffe lang G

Manchon long G

Threaded socket long G

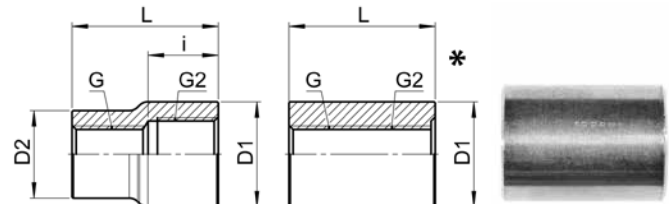

AD C 50

Type -G -G2	Mat.-Nr.	bar	L	D1	D2	i	kg/100
G=Rohrgewinde (zylindrisch)	G=Filetage-gaz BSP (cylindrique)				G=BSP thread (parallel)		
G2=Rohrgewinde (zylindrisch)	G2=Filetage-gaz BSP (cylindrique)				G2=BSP thread (parallel)		
AD C 50-1/8-1/8 *	TAD.5140.042	400	17.0	14.0	0.0	0.0	1.150
AD C 50-1/8-1/4	TAD.5140.044	400	25.0	18.0	15.0	17.0	2.540
AD C 50-1/4-1/4	TAD.5140.104	400	25.0	18.0	0.0	0.0	2.150
AD C 50-1/4-3/8	TAD.5140.106	400	30.0	22.5	17.5	16.0	5.140
AD C 50-1/4-1/2	TAD.5140.108	400	37.0	28.0	18.0	17.0	8.600
AD C 50-3/8-3/8 *	TAD.5140.166	400	27.0	22.0	0.0	0.0	3.600
AD C 50-3/8-1/2	TAD.5140.168	400	34.0	28.0	22.0	20.0	7.660
AD C 50-1/2-1/2	TAD.5140.228	400	34.0	27.0	0.0	0.0	5.760
AD C 50-1/2-3/4	TAD.5140.232	200	39.0	33.0	27.0	18.0	13.860
AD C 50-3/4-3/4 *	TAD.5140.292	200	36.0	33.0	0.0	0.0	8.600
AD C 50-3/4-1	TAD.5140.296	200	45.0	40.0	33.0	21.0	26.340
AD C 50-3/4-1 1/4	TAD.5140.298	200	50.0	50.0	33.0	22.0	29.310
AD C 50-1-1 *	TAD.5140.414	200	43.0	40.0	0.0	0.0	15.250
AD C 50-1-1 1/4	TAD.5140.418	200	50.0	50.0	40.0	30.0	34.420

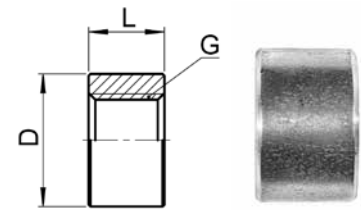
Muffe kurz G
Manchon court G
Threaded socket short G

AD CS 50

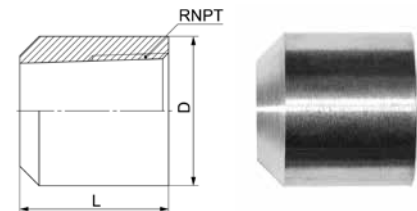
Type -G	Mat.-Nr.	bar	L	D	kg/100
G=Rohrgewinde (zylindrisch)	G=Filetage-gaz BSP (cylindrique)			G=BSP thread (parallel)	
AD CS 50-1/8	TAD.5200.042	400	8.0	14.0	0.500
AD CS 50-1/4	TAD.5200.104	400	11.0	17.0	0.900
AD CS 50-3/8	TAD.5200.166	400	12.0	22.0	1.550
AD CS 50-1/2	TAD.5200.228	400	15.0	27.0	2.600
AD CS 50-3/4	TAD.5200.292	200	17.0	32.0	3.670
AD CS 50-1	TAD.5200.414	200	19.0	40.0	6.100

Hochdruckanschweissmuffe NPT
Manchon à souder pour haute pression NPT
High-pressure weld-on socket NPT

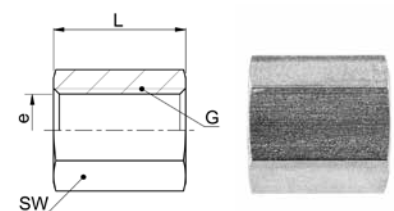
AD FCW 50 NPT

Type -RNPT	Mat.-Nr.	bar	L	D	kg/100
RNPT=NPT Gewinde	RNPT=Filetage NPT			RNPT=NPT thread	
AD FCW 50-1/8 NPT	TAD.5161.042	400	21.0	20.0	3.700
AD FCW 50-1/4 NPT	TAD.5161.104	400	25.0	25.0	6.900
AD FCW 50-3/8 NPT	TAD.5161.166	400	30.0	25.0	7.100
AD FCW 50-1/2 NPT	TAD.5161.228	400	30.0	32.0	11.600
AD FCW 50-1 NPT	TAD.5161.414	200	50.0	50.0	39.500

Sechskantmuffe G
Manchon hexagonal G
Hexagonal threaded socket G

AD HC 50

Type -G	Mat.-Nr.	bar	SW	L	e	kg/100
G=Rohrgewinde (zylindrisch)	G=Filetage-gaz BSP (cylindrique)				G=BSP thread (parallel)	
AD HC 50-1/8	TAD.5100.042	400	17	17.0	8.6	2.280
AD HC 50-1/4	TAD.5100.104	400	22	25.0	11.4	5.500
AD HC 50-3/8	TAD.5100.166	400	22	26.0	15.0	4.400
AD HC 50-1/2	TAD.5100.228	400	27	34.0	18.6	8.430
AD HC 50-3/4	TAD.5100.292	200	32	36.0	24.1	10.690
AD HC 50-1	TAD.5100.414	200	46	43.0	30.3	33.200

Sechskantmuffe G reduziert

Manchon hexagonal G réduit

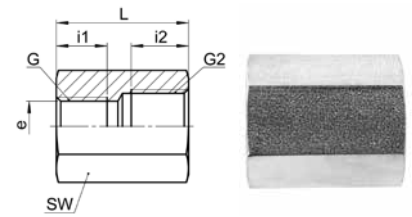
Hexagonal threaded socket G reduced



AD HRC 50

Type -G -G2	Mat.-Nr.	bar	SW	L	i1	i2	e	kg/100
G=Rohrgewinde (zylindrisch)	G=Filetage-gaz BSP (cylindrique)		G=BSP thread (parallel)					
G2=Rohrgewinde (zylindrisch)	G2=Filetage-gaz BSP (cylindrique)		G2=BSP thread (parallel)					
AD HRC 50-1/8-1/4	TAD.5100.044	400	22	25.0	8.0	9.0	8.6	5.940
AD HRC 50-1/8-3/8	TAD.5100.046	400	22	30.0	8.0	9.5	8.6	6.500
AD HRC 50-1/8-1/2	TAD.5100.048	400	27	41.0	8.0	11.5	8.6	14.100
AD HRC 50-1/4-3/8	TAD.5100.106	400	22	29.0	9.0	9.5	11.4	5.750
AD HRC 50-1/4-1/2	TAD.5100.108	400	27	40.0	9.0	11.5	11.4	12.950
AD HRC 50-3/8-1/2	TAD.5100.168	400	27	38.0	9.5	11.5	15.0	10.060
AD HRC 50-1/2-3/4	TAD.5100.232	200	32	41.0	11.5	14.0	18.6	15.200
AD HRC 50-1/2-1	TAD.5100.236	200	46	51.0	11.5	17.0	18.6	48.710

Rohrkappe G

Capuchon G

Hexagonal cap G

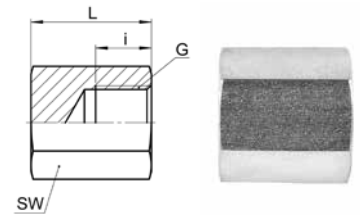

AD HCP 50

Type -G	Mat.-Nr.	bar	SW	L	i	kg/100
G=Rohrgewinde (zylindrisch)	G=Filetage-gaz BSP (cylindrique)		G=BSP thread (parallel)			
AD HCP 50-1/8	TAD.5000.020	400	17	19.0	8.0	2.760
AD HCP 50-1/4	TAD.5000.040	400	22	24.0	9.0	5.940
AD HCP 50-3/8	TAD.5000.060	400	22	27.0	9.5	5.880
AD HCP 50-1/2	TAD.5000.080	400	27	37.0	11.5	12.700
AD HCP 50-3/4	TAD.5000.120	200	32	38.0	14.0	16.370
AD HCP 50-1	TAD.5000.160	200	46	44.0	17.0	43.200

Verschlusschraube R

mit Aussen-6kt.

Bouchon fileté R

à six pans

Screw plug R

with hex-nut

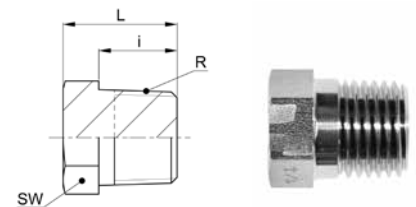

AD HP 50 R

Type -R	Mat.-Nr.	bar	SW	L	i	kg/100
R=Rohrgewinde (kegelig)	R=Filetage-gaz BSP (conique)		R=BSP thread (tapered)			
AD HP 50-1/8	TAD.5020.020	400	12	12.5	8.0	1.020
AD HP 50-1/4	TAD.5020.040	400	14	17.5	12.0	1.900
AD HP 50-3/8	TAD.5020.060	400	17	18.0	12.0	3.290
AD HP 50-1/2	TAD.5020.080	400	22	21.0	14.0	6.550
AD HP 50-3/4	TAD.5020.120	160	27	24.0	16.0	11.680
AD HP 50-1	TAD.5020.160	160	36	28.0	18.0	20.540

Verschlusschraube NPT

mit Aussen-6kt.

Bouchon fileté NPT

à six pans

Screw plug NPT

with hex-nut

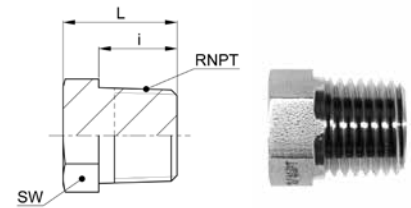

AD HP 50 NPT

Type -RNPT	Mat.-Nr.	bar	SW	L	i	kg/100
RNPT=NPT Gewinde	RNPT=Filetage NPT			RNPT=NPT thread		
AD HP 50-1/8 NPT	TAD.5021.020	400	12	15.5	9.5	1.070
AD HP 50-1/4 NPT	TAD.5021.040	400	14	18.5	12.5	1.973
AD HP 50-3/8 NPT	TAD.5021.060	400	17	20.5	12.5	3.370
AD HP 50-1/2 NPT	TAD.5021.080	400	22	25.5	17.5	6.647
AD HP 50-3/4 NPT	TAD.5021.120	200	27	29.0	19.0	11.756
AD HP 50-1 NPT	TAD.5021.160	200	36	31.0	21.0	20.472

Verschlusschraube R

mit Innen-6kt.

Bouchon fileté R

avec six pans creux

Screw plug R

locked with Allen key

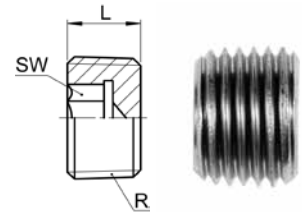

AD SP 50

Type -R	Mat.-Nr.	bar	SW	L	kg/100
R=Rohrgewinde (kegelig)	R=Filetage-gaz BSP (conique)			R=BSP thread (tapered)	
AD SP 50-1/8	TAD.5010.020	400	5	8.0	0.340
AD SP 50-1/4	TAD.5010.040	400	7	10.0	0.740
AD SP 50-3/8	TAD.5010.060	400	8	10.0	1.250
AD SP 50-1/2	TAD.5010.080	400	10	10.0	1.940
AD SP 50-3/4	TAD.5010.110	160	12	12.0	3.800
AD SP 50-1	TAD.5010.160	160	17	12.0	5.760

Verschlusschraube G

mit Aussen-6kt.

Bouchon fileté G

à six pans

Screw plug G

with hex-nut

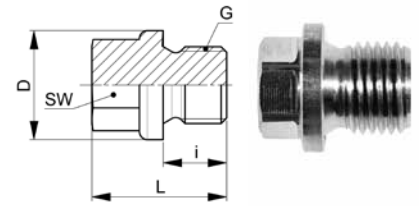

AD HPS 50

Type -G	Mat.-Nr.	bar	SW	L	D	i	kg/100
G=Rohrgewinde (zylindrisch)	G=Filetage-gaz BSP (cylindrique)		G=BSP thread (parallel)				
AD HPS 50-1/8	TAD.5030.020	400	10	17.0	14.0	8.0	1.160
AD HPS 50-1/4	TAD.5030.040	400	13	21.0	18.0	12.0	2.600
AD HPS 50-3/8	TAD.5030.060	400	17	21.0	22.0	12.0	3.960
AD HPS 50-1/2	TAD.5030.080	400	19	26.0	26.0	14.0	6.960
AD HPS 50-3/4	TAD.5030.120	200	24	30.0	32.0	16.0	12.620
AD HPS 50-1	TAD.5030.160	200	27	32.0	39.0	16.0	19.900

Einschraubgewinde nach DIN 3852-2 Form A.
Beim Einbau empfiehlt sich die Verwendung einer Dichtscheibe (z.B. SO 40007).
Die Dichtung muss bei Bedarf separat bestellt werden.

Filetage mâle selon DIN 3852-2 Forme A.
L'utilisation d'un joint (par exemple SO 40007) est recommandée pour l'installation.
Si nécessaire, le joint correspondant doit être commandé séparément.

Male adaptor thread according to DIN 3852-2 Form A.
The use of a sealing washer (e.g. SO 40007) is recommended for installation.
If required, the corresponding washer must be ordered separately.

Verschlusschraube G

mit Aussen-6kt. und Conovor O-Ringabdichtung (FKM)

Bouchon fileté G

à six pans, avec joint torique système Conovor (FKM)

Screw plug G

with hex-nut and Conovor O-ring seal (FKM)

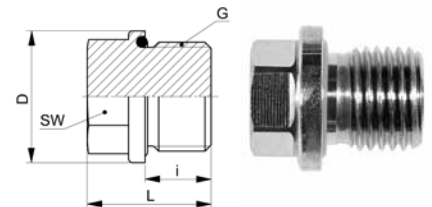

AD HPO 50

Type -G	Mat.-Nr.	bar	SW	L	D	i	O-Ring	kg/100
G=Rohrgewinde (zylindrisch)	G=Filetage-gaz BSP (cylindrique)		G=BSP thread (parallel)					
AD HPO 50-1/8	TAD.5040.020	400	10	17.0	14.0	8.0	8.73x1.78	1.180
AD HPO 50-1/4	TAD.5040.040	400	13	21.0	18.0	12.0	11.1x1.78	2.280
AD HPO 50-3/8	TAD.5040.060	400	17	21.0	22.0	12.0	14.0x1.78	3.780
AD HPO 50-1/2	TAD.5040.080	400	19	26.0	26.0	14.0	18.72x2.62	7.000

Verschlusschraube G

mit Innen-6kt.

Bouchon fileté G

avec six pans creux

Screw plug G

locked with Allen key

AD HSP 50

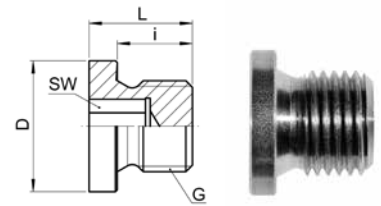

Type -G	Mat.-Nr.	bar	SW	L	D	i	kg/100
G=Rohrgewinde (zylindrisch)	G=Filetage-gaz BSP (cylindrique)		G=BSP thread (parallel)				
AD HSP 50-1/8	TAD.5070.020	400	5	11.0	14.0	8.0	0.650
AD HSP 50-1/4	TAD.5070.040	400	6	15.0	18.0	12.0	1.470
AD HSP 50-3/8	TAD.5070.060	400	8	15.0	22.0	12.0	2.320
AD HSP 50-1/2	TAD.5070.080	400	10	18.0	26.0	14.0	4.350
AD HSP 50-3/4	TAD.5070.120	200	12	20.0	32.0	16.0	7.700
AD HSP 50-1	TAD.5070.160	200	17	21.0	39.0	16.0	12.000

Einschraubgewinde nach DIN 3852-2 Form A.
Beim Einbau empfiehlt sich die Verwendung einer Dichtscheibe (z.B. SO 40007).
Die Dichtung muss bei Bedarf separat bestellt werden.

Filetage mâle selon DIN 3852-2 Forme A.
L'utilisation d'un joint (par exemple SO 40007) est recommandée pour l'installation.
Si nécessaire, le joint correspondant doit être commandé séparément.

Male adaptor thread according to DIN 3852-2 Form A.
The use of a sealing washer (e.g. SO 40007) is recommended for installation.
If required, the corresponding washer must be ordered separately.

Verschlusschraube G

mit Innen-6kt. und Conovor O-Ringabdichtung (FKM)

Bouchon fileté G

avec six pans creux et joint torique système Conovor (FKM)

Screw plug G

locked with Allen key and Conovor O-ring seal (FKM)

AD HSPO 50

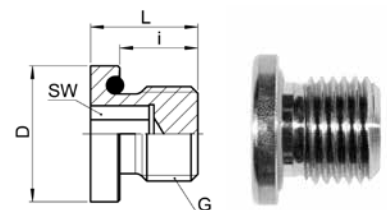

Type -G	Mat.-Nr.	bar	SW	L	D	i	O-Ring	kg/100
G=Rohrgewinde (zylindrisch)	G=Filetage-gaz BSP (cylindrique)		G=BSP thread (parallel)					
AD HSPO 50-1/8	TAD.5050.020	400	5	11.0	14.0	8.0	8.73x1.78	0.610
AD HSPO 50-1/4	TAD.5050.040	400	6	15.0	18.0	12.0	11.1x1.78	1.410
AD HSPO 50-3/8	TAD.5050.060	400	8	15.0	22.0	12.0	14.0x1.78	2.200
AD HSPO 50-1/2	TAD.5050.080	400	10	18.0	26.0	14.0	18.72x2.62	4.130
AD HSPO 50-3/4	TAD.5050.120	200	12	20.0	32.0	16.0	23.47x2.62	7.380

Sechskant-Kontermutter Contre-écrou à six pans Hexagonal counter nut

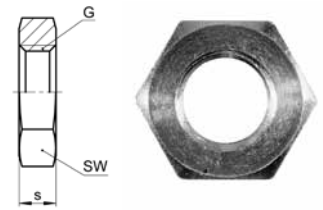

AD HCN 50

Type -G	Mat.-Nr.	SW	s	kg/100
G=Rohrgewinde (zylindrisch)	G=Filetage-gaz BSP (cylindrique)		G=BSP thread (parallel)	
AD HCN 50-1/8	TAD.5900.042	19	6.00	1.200
AD HCN 50-1/4	TAD.5900.104	22	6.00	1.430
AD HCN 50-3/8	TAD.5900.166	27	7.00	2.370
AD HCN 50-1/2	TAD.5900.228	32	8.00	3.000
AD HCN 50-3/4	TAD.5900.292	36	9.00	4.260

Aufschraub-Winkel G Coude femelle G Female threaded elbow G

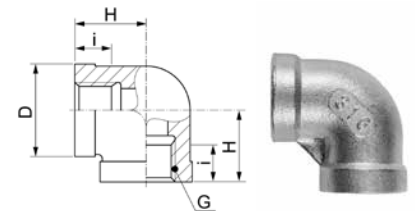

AD FE 51

Type -G	Mat.-Nr.	bar	D	H	i	kg/100
G=Rohrgewinde (zylindrisch)	G=Filetage-gaz BSP (cylindrique)			G=BSP thread (parallel)		
AD FE 51-1/8-1/8	TAD.5300.042	10	14.5	17.0	6.0	3.700
AD FE 51-1/4-1/4	TAD.5300.104	10	17.5	19.0	8.0	5.100
AD FE 51-3/8-3/8	TAD.5300.166	10	20.0	23.0	9.0	6.600
AD FE 51-1/2-1/2	TAD.5300.228	10	27.5	27.0	9.5	9.000
AD FE 51-3/4-3/4	TAD.5300.292	10	31.5	31.5	11.5	19.100
AD FE 51-1-1	TAD.5300.414	10	39.0	36.5	14.0	27.800

Alle Angaben verstehen sich als unverbindliche Richtwerte. Für nicht schriftlich bestätigte Datenauswahl übernehmen wir keine Haftung.

Toutes les spécifications sont des valeurs indicatives sans engagement. Nous déclinons toute responsabilité pour la sélection des données non confirmée par écrit.

All specifications are non-binding standard values. We assume no liability for data selection not confirmed in writing.

Einschraub-/Aufschraub-Winkel G-R

Coude mâle - femelle G-R

Male/female threaded elbow G-R

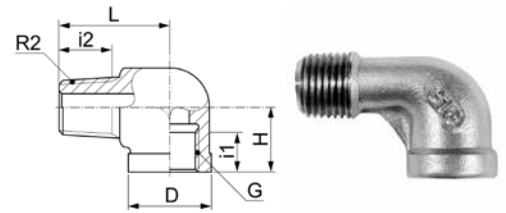

AD SE 51

Type -G-R2	Mat.-Nr.	bar	L	D	H	i1	i2	kg/100
G=Rohrgewinde (zylindrisch)								
R2=Rohrgewinde (kegelig)								

Alle Angaben verstehen sich als unverbindliche Richtwerte. Für nicht schriftlich bestätigte Datenauswahl übernehmen wir keine Haftung.

Toutes les spécifications sont des valeurs indicatives sans engagement. Nous déclinons toute responsabilité pour la sélection des données non confirmée par écrit.

All specifications are non-binding standard values. We assume no liability for data selection not confirmed in writing.

Aufschraub-T G

Té femelle G

Female threaded tee G

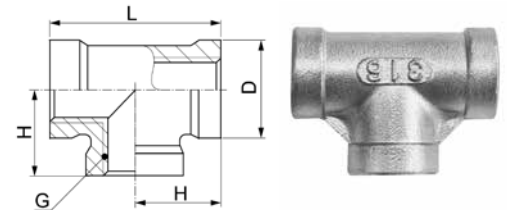

AD FT 51

Type -G	Mat.-Nr.	bar	L	D	H	kg/100
G=Rohrgewinde (zylindrisch)						

Alle Angaben verstehen sich als unverbindliche Richtwerte. Für nicht schriftlich bestätigte Datenauswahl übernehmen wir keine Haftung.

Toutes les spécifications sont des valeurs indicatives sans engagement. Nous déclinons toute responsabilité pour la sélection des données non confirmée par écrit.

All specifications are non-binding standard values. We assume no liability for data selection not confirmed in writing.

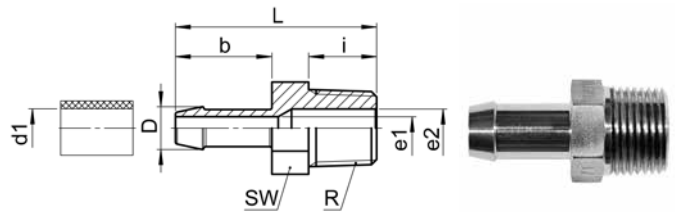
Einschraubtülle R
Douille cannelée à visser R
Male adaptor hose nozzle R

SO 50511

Type -d1 -R	Mat.-Nr.	SW	L	D	i	b	e1	e2	kg/100
R=Rohrgewinde (kegelig)	R=Filetage-gaz BSP (conique)	R=BSP thread (tapered)							
SO 50511-4-1/8	056.0511.060	10	23.0	5.0	8.0	11.0	3.0	6.0	0.560
SO 50511-4-1/4	056.0511.065	14	28.5	5.0	12.0	11.0	3.0	8.5	1.370
SO 50511-6-1/8	056.0511.100	10	29.0	7.5	8.0	17.0	4.0	6.0	0.760
SO 50511-6-1/4	056.0511.110	14	34.5	7.5	12.0	17.0	5.0	8.5	1.460
SO 50511-6-3/8	056.0511.120	17	35.0	7.5	12.0	17.0	5.0	10.5	2.290
SO 50511-6-1/2	056.0511.125	22	40.0	7.5	16.0	17.0	5.0	13.0	4.630
SO 50511-8-1/8	056.0511.160	10	29.0	9.5	8.0	17.0	6.0	6.0	0.850
SO 50511-8-1/4	056.0511.170	14	34.5	9.5	12.0	17.0	6.0	8.5	1.640
SO 50511-8-3/8	056.0511.180	17	35.0	9.5	12.0	17.0	6.0	10.5	2.470
SO 50511-8-1/2	056.0511.185	22	40.0	9.5	16.0	17.0	6.0	13.0	4.800
SO 50511-10-1/4	056.0511.270	14	36.5	11.5	12.0	19.0	8.0	8.0	1.820
SO 50511-10-3/8	056.0511.280	17	37.0	11.5	12.0	19.0	8.0	10.5	2.550
SO 50511-10-1/2	056.0511.285	22	42.0	11.5	16.0	19.0	8.0	13.0	4.910
SO 50511-12,7-1/4	056.0511.380	17	52.0	15.0	12.0	33.0	8.0	8.0	4.260
SO 50511-13-3/8	056.0511.450	17	39.0	15.0	12.0	21.0	11.0	11.0	2.640
SO 50511-13-1/2	056.0511.454	22	44.0	15.0	16.0	21.0	11.0	11.0	5.590
SO 50511-16-1/2	056.0511.566	22	49.0	18.0	16.0	26.0	13.0	13.0	5.720
SO 50511-19-1/2	056.0511.676	22	49.0	21.5	16.0	26.0	16.0	16.0	4.930
SO 50511-19-3/4	056.0511.678	27	51.0	21.5	16.5	26.0	16.0	16.0	9.170
SO 50511-25-1	056.0511.810	36	59.0	27.5	20.0	29.0	22.0	22.0	16.000

d1 = Schlauchinnendurchmesser

d1 = diamètre intérieur du tuyau

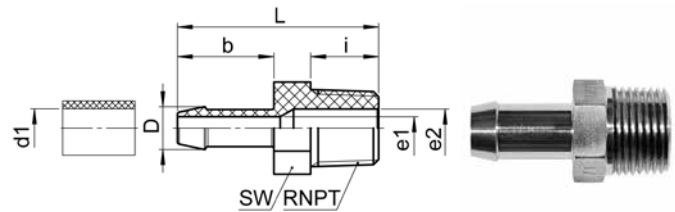
d1 = hose inside diameter

Einschraubtülle NPT
Douille cannelée à visser NPT
Male adaptor hose nozzle NPT

SO 50511 NPT

Type -d1 -RNPT	Mat.-Nr.	SW	L	D	i	b	e1	e2	kg/100
RNPT=NPT Gewinde	RNPT=Filetage NPT			RNPT=NPT thread					
SO 50511-4-1/8 NPT	056.0512.060	12	25.5	5.0	10.0	11.0	3.0	3.0	1.040
SO 50511-4-1/4 NPT	056.0512.065	14	30.5	5.0	14.0	11.0	3.0	6.5	1.900
SO 50511-6-1/8 NPT	056.0512.100	12	31.5	7.5	10.0	17.0	5.0	5.0	1.020
SO 50511-6-1/4 NPT	056.0512.110	14	36.5	7.5	14.0	17.0	5.0	6.5	1.990
SO 50511-8-1/8 NPT	056.0512.160	12	31.5	9.5	10.0	17.0	6.0	6.0	1.120
SO 50511-8-1/4 NPT	056.0512.170	14	36.5	9.5	14.0	17.0	6.0	6.0	2.230
SO 50511-10-1/4 NPT	056.0512.270	14	38.5	11.5	14.0	19.0	8.0	8.0	2.050
SO 50511-10-3/8 NPT	056.0512.280	17	39.0	11.5	14.0	19.0	8.0	8.0	3.350
SO 50511-10-1/2 NPT	056.0512.285	22	45.0	11.5	19.0	19.0	8.0	14.0	5.120
SO 50511-13-3/8 NPT	056.0512.450	17	41.0	15.0	14.0	21.0	11.0	11.0	2.930
SO 50511-13-1/2 NPT	056.0512.454	22	47.0	15.0	19.0	21.0	11.0	14.0	5.300
SO 50511-16-1/2 NPT	056.0512.566	22	52.0	18.0	19.0	26.0	13.0	13.0	6.370
SO 50511-19-1/2 NPT	056.0512.676	22	52.0	21.5	19.0	26.0	16.0	16.0	5.420
SO 50511-19-3/4 NPT	056.0512.678	30	55.0	21.5	20.0	26.0	16.0	16.0	11.440
SO 50511-25-3/4 NPT	056.0512.805	30	59.0	27.5	20.0	29.0	19.0	19.0	12.410
SO 50511-25-1 NPT	056.0512.810	36	63.0	27.5	25.0	29.0	22.0	22.0	17.430

d1 = Schlauchinnendurchmesser

d1 = diamètre intérieur du tuyau

d1 = hose inside diameter

Einschraubtülle G

mit Conovor O-Ringabdichtung (FKM)

Douille cannelée à visser G

avec joint torique système Conovor (FKM)

Male adaptor hose nozzle G

with Conovor O-ring seal (FKM)

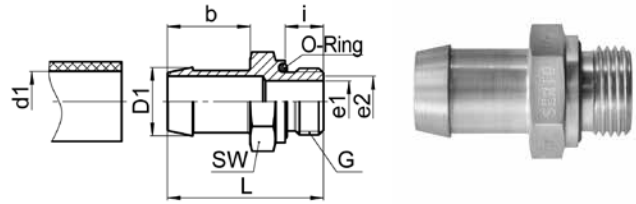

SO 10511 OR

Type -d1 -G	Mat.-Nr.	SW	L	D1	D2	i	b	t	O-Ring	e1	e2	kg/100
SO 10511-19-1/2 OR	118.0511.676	27	49.0	21.5	27.0	12.0	26.0	2.5	18.72x2.62	13.0	16.0	2.600

Einbauempfehlung:

Conseil de montage:

Recommendation for installation:

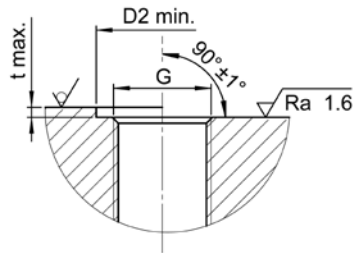

Einsatztemperaturbereich: -20 °C bis +120 °C

Die Vorteile dieser O-Ringabdichtung:

- keine Dichtmittelreste in Geräten
- einwandfreie Abdichtung
- keine Beschädigung von Geräten durch konische Gewinde
- schnelle Montage

Conovor patentierte O-Ring Abdichtung

d1 = Schlauchinnendurchmesser

Plage de température de service: -20 °C à +120 °C

Les avantages de cette étanchéité à joint torique:

- aucun reste de scellant dans les équipements
- une étanchéité parfaite
- aucun endommagement de l'équipement par le filetage conique
- facilité d'installation

Etanchéité à joint torique brevetée Conovor

d1 = diamètre intérieur du tuyau

Operating temperature range: -20 °C to +120 °C

Advantages of this O-ring seal:

- no sealing residues in devices
- perfect seal
- no damage to devices due to tapered thread
- rapid assembly

Conovor patented O-ring seal

d1 = hose inside diameter

Adapter Kunststoff

Adaptateurs plastique

Adaptors plastic

Eigenschaften, Besonderheiten

- einfache Verbindungselemente mit Innen- und Aussengewinden, Tüllen und Abschlusselementen
- zahlreiche Bauformen
- viele Kombinationsmöglichkeiten

Betriebsdruck PN

10 bar bei +23 °C (3-fache Sicherheit), höhere Drücke in Kombination mit SERTO Kunststoffrohren auf Anfrage (bar+).

Werkstoff

- PVDF (Polyvinylidenfluorid)
- PA (Polyamid 6.6)

FDA-Konformität

Polyvinylidenfluorid (PVDF) entspricht der CFR* 21, § 177.2510 der FDA (Food and Drug Administration, USA) und kann für den Einsatz im Kontakt mit Lebensmittel verwendet werden. FKM-O-Ringe sind ebenfalls FDA-konform.

*Code of Federal Regulations

Herstellung

Spritzguss

Gewinde

G = Rohrgewinde BSP (zylindrisch) ISO 228
R = Rohrgewinde (kegelig) EN 10226-1

Propriétés, spécificités

- éléments simples d'assemblage avec des filetages intérieurs et extérieurs, des douilles et des éléments de fermeture
- grand nombre de formes de construction
- nombreuses possibilités de combinaison

Pression de service PN

10 bar à +23 °C (facteur de sécurité 3), pressions plus élevées en combinaison avec les tubes plastiques SERTO sur demande (bar+).

Matériaux

- PVDF (fluorure de polyvinylidène)
- PA (polyamide 6.6)

Conformité FDA

Fluorure de polyvinylidène (PVDF) est en conformité avec le CFR* 21, § 177.2510 de la FDA (Food and Drug Administration, USA) et peut être utilisé en contact avec aliments. Les joints toriques sont aussi conformes à la FDA.

*Code of Federal Regulations

Fabrication

moulage par injection

Filetages

G = filetage gas BSPP (cylindrique) ISO 228
R = filetage gas BSP (conique) EN 10226-1

Characteristics, specialities

- simple connecting pieces with internal and external threads, hose nozzles and end elements
- large number of design types
- many possible combinations

Working pressure PN

10 bar at +23 °C (safety factor of 3), higher pressures in combination with SERTO plastic tubes on request (bar+).

Materials

- PVDF (polyvinylidene fluoride)
- PA (polyamide 6.6)

FDA-Compliance

Polyvinylidene fluoride complies with the CFR* 21, § 177.2510 of FDA (Food and Drug Administration, USA) and can be used in contact with food. FKM-O-rings are also FDA-compliant.

*Code of Federal Regulations

Manufacture

injection moulding

Threads

G = BSP pipe thread (straight) ISO 228
R = BSP pipe thread (tapered) EN 10226-1

Übergangsmuffe G-G

Adaptateur femelle G - femelle G

Female adaptor G-G

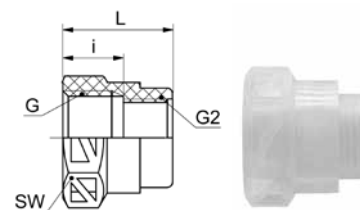

SO 20031

Type -G -G2	Mat.-Nr.	bar +	SW	L	i	kg/100
G=Rohrgewinde (zylindrisch)	G=Filetage-gaz BSP (cylindrique)		G=BSP thread (parallel)			
G2=Rohrgewinde (zylindrisch)	G2=Filetage-gaz BSP (cylindrique)		G2=BSP thread (parallel)			
SO 20031-1/8-1/8	126.0311.042	10	14	16.0	8.0	0.190
SO 20031-1/4-1/8	126.0311.044	10	17	17.0	10.0	0.310
SO 20031-3/8-1/8	126.0311.046	10	22	18.0	11.0	0.530
SO 20031-1/2-1/8	126.0311.048	10	27	21.0	14.0	1.070
SO 20031-1/4-1/4	126.0311.104	10	17	17.5	9.0	0.320
SO 20031-3/8-1/4	126.0311.106	10	22	19.0	11.0	0.550
SO 20031-1/2-1/4	126.0311.108	10	27	22.0	14.0	1.010
SO 20031-3/8-3/8	126.0311.166	10	22	19.0	9.5	0.540
SO 20031-1/2-3/8	126.0311.168	10	27	22.5	14.0	1.050

Übergangsnippel G-R

Adaptateur femelle G - mâle R

Adaptor female G- male R

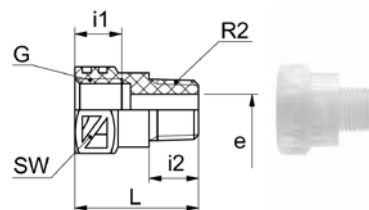

SO 20041

Type -G -R2	Mat.-Nr.	bar +	SW	L	i1	i2	e	kg/100
G=Rohrgewinde (zylindrisch)	G=Filetage-gaz BSP (cylindrique)		G=BSP thread (parallel)					
R2=Rohrgewinde (kegelig)	R2=Filetage-gaz BSP (conique)		R2=BSP thread (tapered)					
SO 20041-1/8-1/8	126.0411.042	10	14	20.0	7.0	8.0	6.0	0.220
SO 20041-1/8-1/4	126.0411.044	10	14	24.0	7.0	12.0	8.6	0.310
SO 20041-1/8-3/8	126.0411.046	10	17	25.0	7.0	12.0	8.6	0.650
SO 20041-1/8-1/2	126.0411.048	10	22	30.0	7.0	16.0	8.6	1.130
SO 20041-1/4-1/8	126.0411.102	10	17	21.0	8.0	8.0	6.0	0.340
SO 20041-1/4-1/4	126.0411.104	10	17	25.0	8.0	12.0	6.5	0.480
SO 20041-1/4-3/8	126.0411.106	10	17	25.0	8.0	12.0	11.5	0.470
SO 20041-1/4-1/2	126.0411.108	10	22	30.0	8.0	16.0	11.5	1.030
SO 20041-3/8-1/4	126.0411.164	10	22	26.0	8.5	12.0	6.7	0.690
SO 20041-3/8-3/8	126.0411.166	10	22	26.0	8.5	12.0	8.0	0.810
SO 20041-3/8-1/2	126.0411.168	10	22	30.0	8.5	16.0	15.0	0.860

Übergangsnippel G-G

mit O-Ringabdichtung (FKM)

Adaptateur femelle G - mâle G

avec joint torique (FKM)

Adaptor female G - male G

with O-ring seal (FKM)

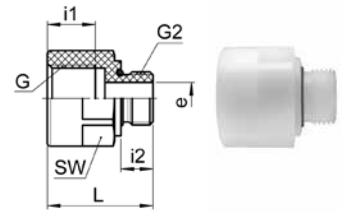

SO 20041 OR

Type -G -G2	Mat.-Nr.	bar +	SW	L	i1	i2	O-Ring	e	kg/100
G=Rohrgewinde (zylindrisch)									
G2=Rohrgewinde (zylindrisch)									
SO 20041-1/2-3/8 OR	128.0471.001	10	27	33.0	15.0	10.0	14.0x1.78	10.0	1.830

Verschlusschraube R

mit Aussen-6kt.

Bouchon fileté R

à six pans

Screw plug R

with hex-nut

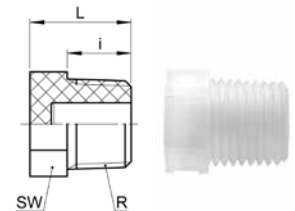

SO 20371

Type -R	Mat.-Nr.	SW	L	i	kg/100
R=Rohrgewinde (kegelig)					
SO 20371-1/8	126.0721.020	12	13.0	8.0	0.170
SO 20371-1/4	126.0721.040	14	18.5	12.0	0.370
SO 20371-3/8	126.0721.060	17	19.0	12.0	0.610
SO 20371-1/2	126.0721.080	22	24.0	16.0	1.150

Einschraubtülle R

Douille cannelée à visser R

Male adaptor hose nozzle R

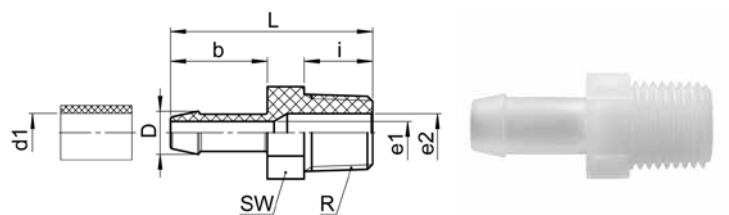

SO 20511

Type -d1 -R	Mat.-Nr.	bar +	SW	L	D	i	b	e1	e2	kg/100
R=Rohrgewinde (kegelig)										
SO 20511-4-1/8	126.0511.060	10	12	24.0	5.0	8.0	11.0	3.0	5.1	0.190
SO 20511-6-1/8	126.0511.100	10	12	30.5	7.5	8.0	17.0	4.0	5.1	0.230
SO 20511-6-1/4	126.0511.110	10	14	35.5	7.5	12.0	17.0	4.0	6.7	0.430
SO 20511-8-1/4	126.0511.170	10	14	35.5	9.5	12.0	17.0	6.0	6.7	0.440
SO 20511-10-3/8	126.0511.280	10	17	38.0	11.5	12.0	19.0	7.0	8.0	0.750
SO 20511-12-3/8	126.0511.390	10	17	38.0	13.5	12.0	19.0	10.0	10.0	0.650
SO 20511-12-1/2	126.0511.400	10	22	43.0	13.5	16.0	19.0	10.0	12.0	1.260

d1 = Schlauchinnendurchmesser

d1 = diamètre intérieur du tuyau

d1 = hose inside diameter

Doppelnippel R
Mamelon double R
Male threaded adaptor R

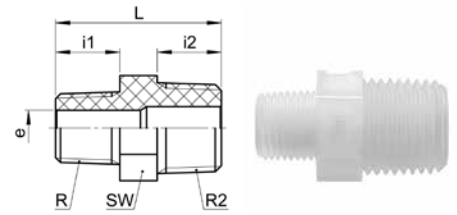
SO 21109

Type -R -R2	Mat.-Nr.	bar +	SW	L	i1	i2	e	kg/100
R=Rohrgewinde (kegelig)	R=Filetage-gaz BSP (conique)							
R2=Rohrgewinde (kegelig)	R2=Filetage-gaz BSP (conique)							
SO 21109-1/8-1/8	126.0641.042	10	12	21.0	8.0	8.0	5.1	0.230
SO 21109-1/8-1/4	126.0641.044	10	14	26.5	8.0	12.0	5.1	0.420
SO 21109-1/4-1/4	126.0641.104	10	14	30.5	12.0	12.0	6.7	0.540
SO 21109-1/4-3/8	126.0641.106	10	17	31.0	12.0	12.0	6.7	0.770
SO 21109-1/4-1/2	126.0641.108	10	22	36.0	12.0	16.0	6.7	1.310
SO 21109-3/8-3/8	126.0641.166	10	17	31.0	12.0	12.0	8.0	0.880
SO 21109-3/8-1/2	126.0641.168	10	22	36.0	12.0	16.0	8.0	1.410
SO 21109-1/2-1/2	126.0641.228	10	22	40.0	16.0	16.0	12.0	1.620
SO 21109-1/2-3/4	126.0641.232	10	27	41.5	16.0	16.5	12.0	2.210

Einschraubtülle R
Douille cannelée à visser R
Male adaptor hose nozzle R

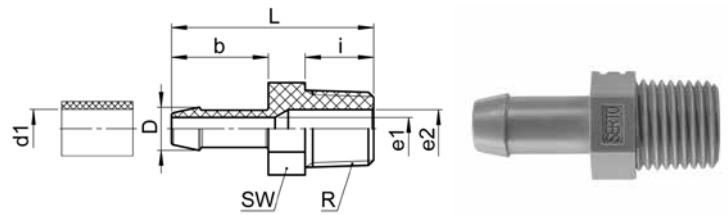
SO 30511

Type -d1 -R	Mat.-Nr.	bar +	SW	L	D	i	b	e1	e2	kg/100
R=Rohrgewinde (kegelig)	R=Filetage-gaz BSP (conique)	R=BSP thread (tapered)								
SO 30511-6-1/8	166.0511.100	10	12	30.0	7.5	8.0	17.0	4.0	5.1	0.170
SO 30511-6-1/4	166.0511.110	10	14	35.5	7.5	12.0	17.0	4.0	6.7	0.270
SO 30511-8-1/4	166.0511.170	10	14	36.0	9.5	12.0	17.5	6.0	6.7	0.340
SO 30511-10-3/8	166.0511.280	10	17	38.0	11.5	12.0	19.0	7.0	8.0	0.470
SO 30511-12-3/8	166.0511.390	10	17	38.0	13.5	12.0	19.0	10.0	10.0	0.400
SO 30511-12-1/2	166.0511.400	10	22	43.0	13.5	16.0	19.0	10.0	12.0	0.780

d1 = Schlauchinnendurchmesser

d1 = diamètre intérieur du tuyau

d1 = hose inside diameter

Rohrkompensierverbindung

Compensateur de tube

Tube compensator

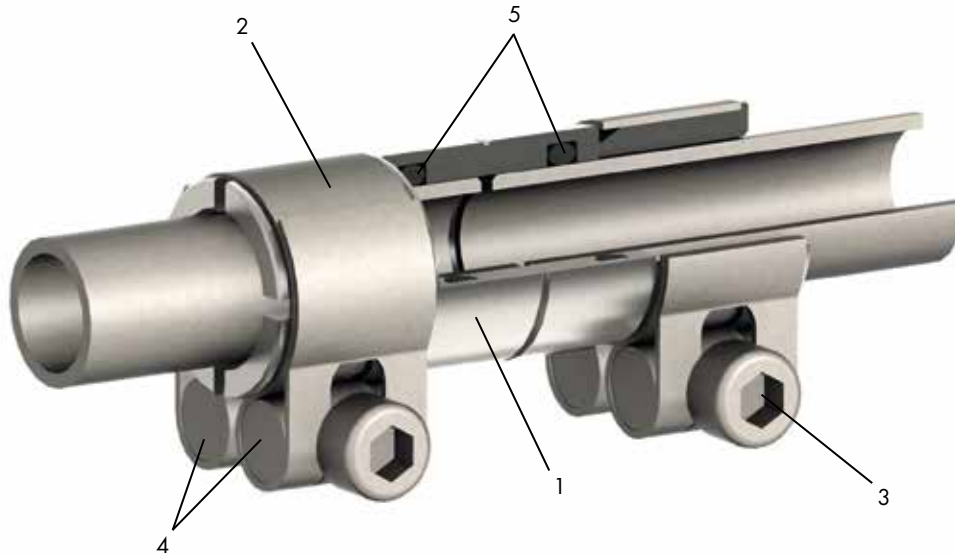
RK 51900

Nr. No. No.	Bezeichnung Désignation Description	Material Matériau Material	Nr. No. No.	Bezeichnung Désignation Description	Material Matériau Material	Nr. No. No.	Bezeichnung Désignation Description	Material Matériau Material
1	Schiebekörper Corps Body	Inox 1.4305	3	Innensechskantschraube Vis à six-pans creux Hexagon socket screw	Inox 1.4301	5*	Dichtung Joint Seal	VMQ
2	Gelenkbolzenschelle Collier articulé Hinge bolt clamp	Inox 1.4301	4	Querbolzen Boulon transversal Cross bolt	Messing CV Laiton CV Brass CV			

Spezifikationen

Betriebsdruck (PN): 5 bis 40 bar
 Temperatur: -60°C bis +250°C
 Sicherheitsfaktor: 3-fach

Merkmale

Mit der Rohrkompensierverbindung können zwei Röhre einfach miteinander verbunden werden.

* Optionen erhältlich

No. 5 - Dichtung: andere Materialien auf Anfrage

Spécifications

Pression de service (PN): 5 à 40 bar
 Température: -60°C à +250°C
 Facteur de sécurité: 3 fois

Caractéristiques

Avec le compensateur de tube, deux tubes peuvent être interconnectés d'une manière simple.

* Options disponible

No. 5 - Joint: autres joints sur demande

Specifications

Working pressure (PN): 5 to 40 bar
 Temperature: -60°C to +250°
 Safety factor: 3 times

Characteristics

With the tube compensator, two tubes can be interconnected in a simple way.

* Options available

No. 5 - Seal: other materials on request

Betriebsdruck
Pression de service
Working pressure

Der Versuchsaufbau zur Bestimmung der min. Nenndruckwerte bestand aus zwei mit einer Rohrkompensierverbindung RK 51900 verbundenen und seitlich nicht fixierten Rohrabschnitten. Daraus resultieren die angegebenen Werte mit Berücksichtigung der 3-fachen Sicherheit.

L'installation expérimentale pour déterminer les valeurs min. de pression nominale consistait en deux sections de tube non fixées sur les côtés et raccordées par un compensateur de tube RK 51900. Les valeurs indiquées ont ainsi été relevées en tenant compte de la triple sécurité.

The test setup for the determination of the min. working pressure values consisted of two tube sections, not fastened at the sides, connected to a tube compensator RK 51900. The values stated are the result of this test and in consideration of a safety factor of 3.



Versuchsaufbau / installation expérimentale / test setup

In der Praxis sind in einem geschlossenen Rohrsystem die Rohrabschnitte immer durch Rohrschellen, Wanddurchführungen, Bögen in der Leitung oder andere Befestigungen fixiert, was ein Ausgleiten aus der Rohrkompensierverbindung verhindert.

En pratique, les sections de tube dans un système de tubes fermé sont toujours fixées à l'aide de colliers de serrage, de traversées murales, de coudes dans la conduite ou d'autres fixations, ce qui les empêche de glisser hors du compensateur de tube.

Typically, the tube sections of a closed system are always fixed by tube clamps, wall ducts, bends in the tube or other fastenings, which prevent the sliding of the tube out of the compensator.

Abhängig von Anzahl, Qualität und Materialauswahl der Sicherungselemente sind deutlich höhere Betriebsdrücke als die hier angegebenen möglich. Werden die in der Praxis empfohlenen Maße für freie Rohrabschnitte eingehalten, sind Drücke von 10 bar (Personenverkehr) bis 16 bar (Güterverkehr) problemlos erreichbar.

En fonction du nombre, de la qualité et du choix des matériaux des éléments de sécurité, des pressions de service nettement plus élevées que celles indiquées ici sont possibles. Si les dimensions conseillées pour les sections de tube libres sont respectées dans la pratique, des pressions de 10 bars (transport de passagers) à 16 bars (transport de marchandises) peuvent être atteintes sans problème.

Depending on the number, quality and material of the securing elements, significantly higher operating pressures than those specified are possible. If the usually recommended measures for not-fixed tube sections are followed, pressures from 10 bar (passenger transportation) up to 16 bar (freight transportation) can easily be reached.

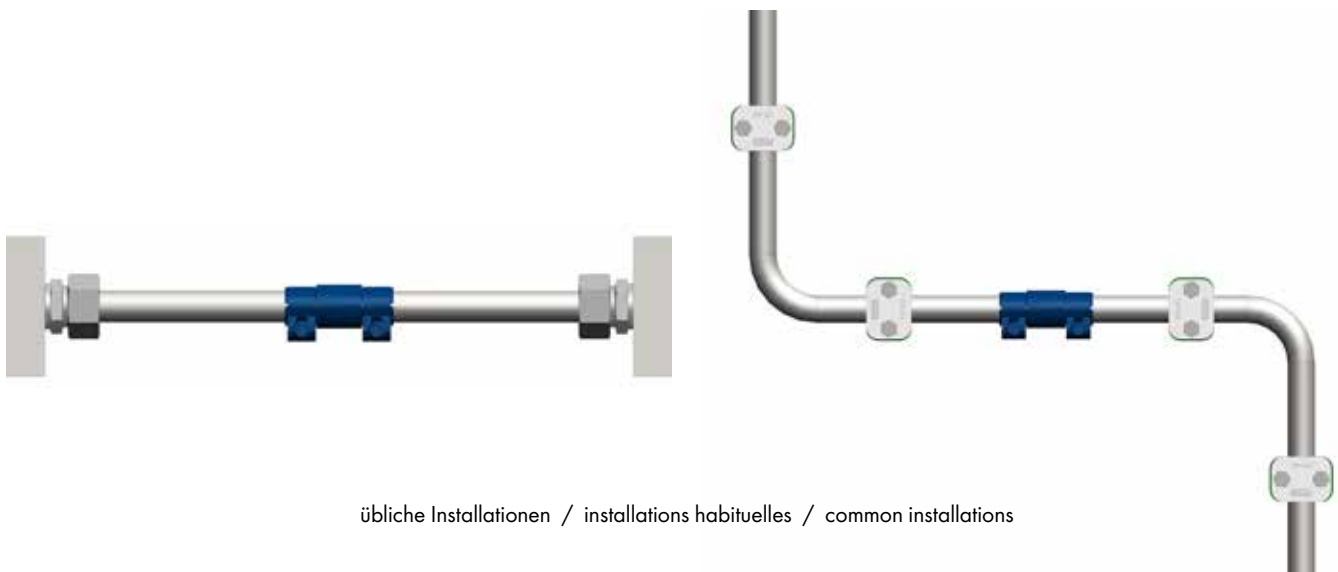

übliche Installationen / installations habituelles / common installations

Rohrkompensierverbindung

Compensateur de tube

Tube compensator

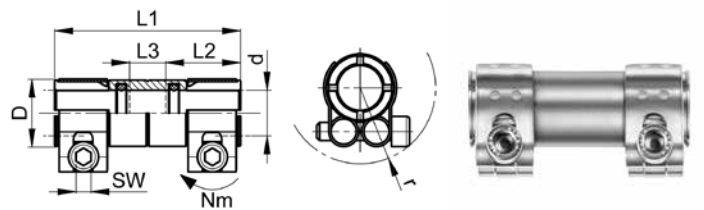

RK 51900 VMQ

Type -d	Mat.-Nr.	bar	SW	L1	L2	L3	D	Nm	r	kg/100
RK 51900-10 VMQ	YEA.510.0710	40	3	48.0	18.5	11.0	18.0	3	17	4.800
RK 51900-15 VMQ	YEA.510.0711	30	5	62.0	24.0	14.0	22.0	8	26	12.000
RK 51900-18 VMQ	YEA.510.0712	20	5	62.0	24.0	14.0	25.0	8	26	11.000
RK 51900-22 VMQ	YEA.510.0713	10	5	64.0	25.0	14.0	30.0	8	28	13.200
RK 51900-28 VMQ	YEA.510.0714	5	5	64.0	25.0	14.0	38.0	12	32	20.700
RK 51900-35 VMQ	YEA.510.0735	5	5	70.0	25.0	20.0	45.8	12	69	26.500
RK 51900-42 VMQ	YEA.510.0736	5	5	70.0	25.0	20.0	52.0	15	75	30.500

L2 = min. Einstecktiefe
 L3 = max. Rohrabstand
 Nm = Anzugsdrehmoment

L2 = profondeur d'insertion min.
 L3 = distance de tube max.
 Nm = couple de serrage

L2 = min. insertion depth
 L3 = max. tube distance
 Nm = tightening torque