

Die Aluminium-Verschraubung

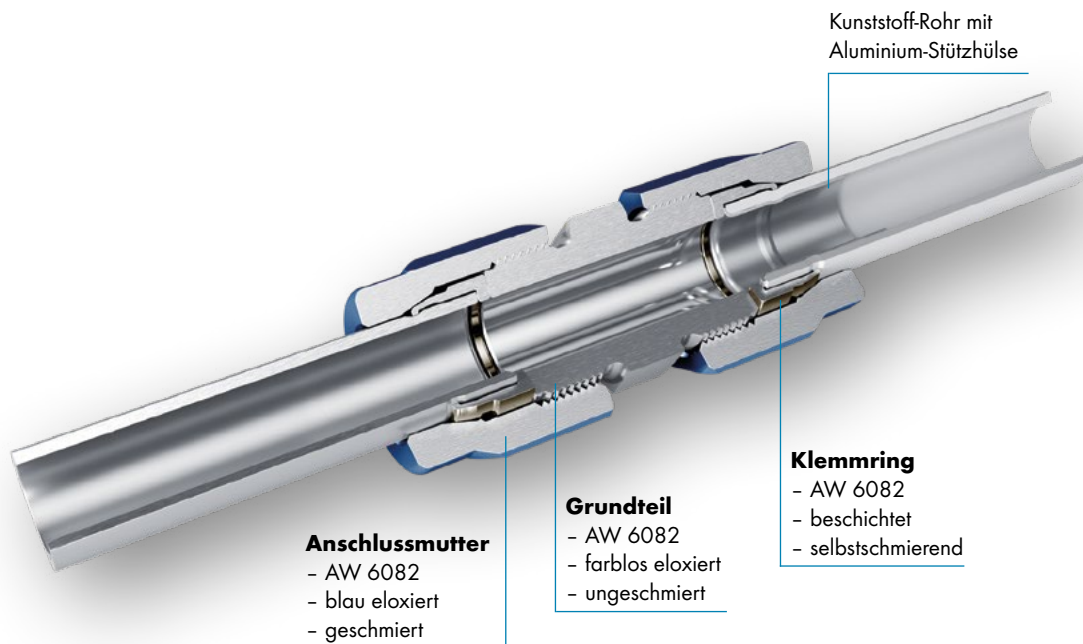

Leicht, robust, vielfältig

Aluminium-Verschraubung mit dem SERTO-Prinzip



Anschlussmutter
 - AW 6082
 - blau eloxiert
 - geschmiert

Grundteil
 - AW 6082
 - farblos eloxiert
 - ungeschmiert

Klemmring
 - AW 6082
 - beschichtet
 - selbstschmierend

Merkmale

Eigenschaft	Kundennutzen
<ul style="list-style-type: none"> • Sehr leicht – rund ein Drittel des Gewichts von Edelstahl oder Messing 	Gewichtseinsparung
<ul style="list-style-type: none"> • Gute Beständigkeit gegen Korrosion, Witterung, Meerwasser, Thermofluide, Mineralöle, Benzin, diverse Gase 	Sicherer Betrieb unter verschiedenen Bedingungen
<ul style="list-style-type: none"> • Initialgeschmiert und damit montagebereit 	Kosten- und Zeitersparnis
<ul style="list-style-type: none"> • Radiales Verschraubungssystem 	Zeit- und Platzersparnis, Sicherheitsgewinn und einfache Montage/Demontage

Anwendungen

- Kühlsysteme in der Leistungselektronik
- Leichtbau-Verrohrungen
- Pneumatik, Treibstoff-, Schmier- und Bremsleitungen in Fahrzeugen

Spezifikationen

Betriebsdruck (PN): bis 100 bar; Details siehe Produkttabellen (4-fache Sicherheit)

Temperatur: -196°C bis +120°C

Heliumleckrate: < 10⁻⁶ mbar • l/s

Rohrempfehlung

Gezogene Rohre mit den Legierungen AW 6060 (T6 / T4) oder AW 5049 (H111) und mit Durchmessertoleranzen nach DIN EN 754-7 (nahtlos gezogen), resp. 754-8 (nicht nahtlos gezogen).

Einsatzgebiete



Energietechnik



Leichtbau



Mobilität

Klemmring

Bague de serrage

Compression ferrule

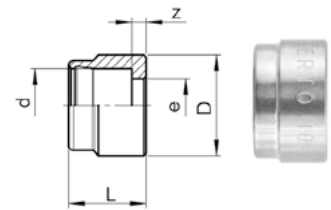

SO 10001

Type-d	Mat.-Nr.	bar	L	D	z	e	kg/100
SO 10001-8	116.0010.080	100	7.0	10.5	1.0	6.0	0.060
SO 10001-10	116.0010.100	100	7.5	12.7	1.0	8.0	0.080
SO 10001-12	116.0010.120	100	8.5	14.7	1.0	9.0	0.120
SO 10001-15	116.0010.150	100	10.0	18.0	1.5	12.0	0.190
SO 10001-18	116.0010.180	100	10.0	22.0	1.5	15.0	0.310
SO 10001-22 OR	116.0009.220	64	11.0	25.7	1.5	18.0	0.390
SO 10001-28 OR	116.0009.280	64	13.0	32.7	2.0	24.0	0.720
SO 10001-35 OR	116.0009.350	40	13.0	39.0	2.0	30.0	0.780

Abschlusszapfen

Bouchon d'arrêt

Plug

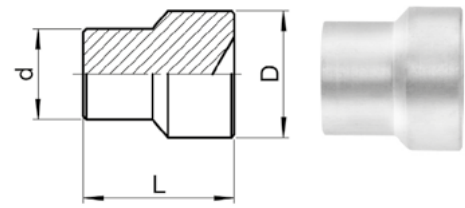

SO 10002

Type-d	Mat.-Nr.	L	D	kg/100
SO 10002-8	116.0020.080	10.5	10.5	0.190
SO 10002-10	116.0020.100	12.0	12.7	0.310
SO 10002-12	116.0020.120	14.0	14.7	0.510
SO 10002-15	116.0020.150	15.0	18.0	0.830
SO 10002-18	116.0020.180	16.8	22.0	1.310
SO 10002-22	116.0020.220	19.0	25.7	2.090
SO 10002-28	116.0020.280	22.5	32.7	4.030
SO 10002-35	116.0020.350	19.0	39.0	4.900

Anwendungsbeispiele:

Der Abschlusszapfen lässt sich in jede Verschraubung anstelle eines Klemmringes der gleichen Grösse einsetzen.

Montagehinweis: Anschlussmutter mit 1/4 Umdrehung anziehen.

Exemples d'utilisation:

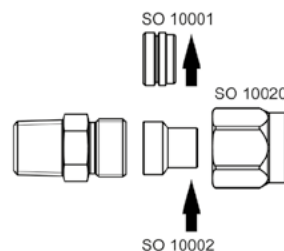

Le bouchon d'arrêt s'insère dans tout raccord au lieu d'une bague de serrage de la même taille.

Note d'installation: Serrez l'écrou d'accouplement de 1/4 de tour.

Sample combinations:

The plug can be inserted into all unions instead of a compression ferrule of the same size.

Assembly information: Tighten the union nut with 1/4 turn.

Stützhülse

zur Rohrverstärkung

Douille d'appui

pour renforcer les tubes

Stiffener sleeve

to reinforce tubes

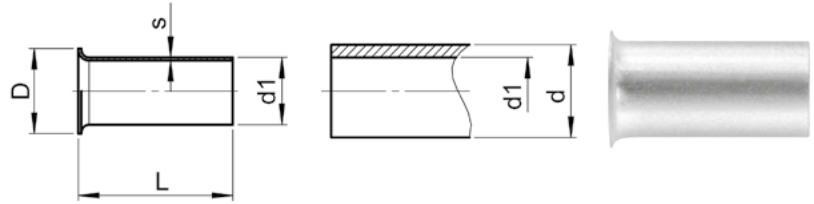
**SO 10003**

Type -d-d1	Mat.-Nr.	L	D	s	kg/100
SO 10003-8-6	116.0030.140	12.0	7.5	0.25	0.020
SO 10003-10-7	116.0030.180	15.0	9.5	0.30	0.030
SO 10003-10-8	116.0030.190	16.0	9.5	0.30	0.030
SO 10003-12-9	116.0030.230	20.0	11.5	0.40	0.060
SO 10003-12-10	116.0030.240	20.0	11.5	0.40	0.060
SO 10003-15-12	116.0030.420	24.0	14.5	0.50	0.120
SO 10003-18-15	116.0030.610	26.0	16.5	0.60	0.190
SO 10003-18-16	116.0030.620	26.0	17.5	0.60	0.200

Werkstoff: Aluminium AW 6060

Matériau: Aluminium AW 6060

Material: Aluminium AW 6060

Für die Verwendung von Aluminium-Verschraubungen in Kombination mit Kunststoff-Rohren.

Pour l'usage des raccords en aluminium en combinaison avec des tubes en plastique.

For the use of aluminium unions in combination with plastic tubes.

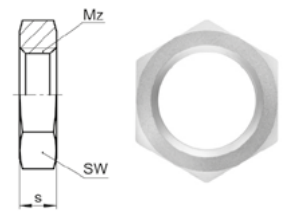
Sechskantmutter METR**Ecrou à six pans METR****Hexagon nut METR****SO 10006 METR**

Type -Mz	Mat.-Nr.	SW	s	kg/100
Mz=metrisches Gewinde (zylindrisch)	Mz=Filetage métrique (cylindrique)	Mz=Metric thread (parallel)		
SO 10006-M14x1	116.0063.220	19	7.00	0.330
SO 10006-M16x1	116.0063.260	22	7.00	0.450
SO 10006-M24x1,5	116.0063.405	30	12.00	1.200
SO 10006-M28x1,5	116.0063.445	36	14.00	2.100

Sechskantmutter für SO 11524, SO 12721

Ecrou à six pans pour SO 11524, SO 12721

Hexagon nut for SO 11524, SO 12721

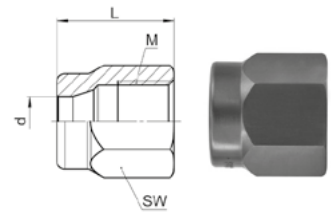
Anschlussmutter**Ecrou****Union nut****SO 10020**

Type-d	Mat.-Nr.	bar	M	SW	L	kg/100
SO 10020-8	116.0200.080	100	12x1.0	14	16.0	0.340
SO 10020-10	116.0200.100	100	14x1.0	17	18.5	0.620
SO 10020-12	116.0200.120	100	16x1.0	19	20.0	0.770
SO 10020-15	116.0200.150	100	20x1.5	24	24.0	1.530
SO 10020-18	116.0200.180	100	24x1.5	30	25.0	2.640
SO 10020-22	116.0200.220	64	28x1.5	32	28.0	2.710
SO 10020-28	116.0200.280	64	36x2.0	41	32.0	4.970
SO 10020-35	116.0200.350	40	42x2.0	50	32.0	7.880

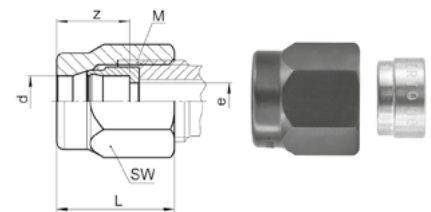
Armaturenanschluss**Ecrou et bague de raccordement****Nut connection****SO 10021**

Type-d	Mat.-Nr.	bar	M	SW	L	z	e	kg/100
SO 10021-8	116.0210.080	100	12x1.0	14	16.0	8.5	6.0	0.400
SO 10021-10	116.0210.100	100	14x1.0	17	18.5	10.5	8.0	0.700
SO 10021-12	116.0210.120	100	16x1.0	19	20.0	12.0	9.0	0.890
SO 10021-15	116.0210.150	100	20x1.5	24	24.0	13.0	12.0	1.720
SO 10021-18	116.0210.180	100	24x1.5	30	25.0	13.5	15.0	2.960
SO 10021-22	116.0210.220	64	28x1.5	32	28.0	16.5	18.0	3.100
SO 10021-28	116.0210.280	64	36x2.0	41	32.0	16.5	24.0	5.690
SO 10021-35	116.0210.350	40	42x2.0	50	32.0	17.0	30.0	8.660

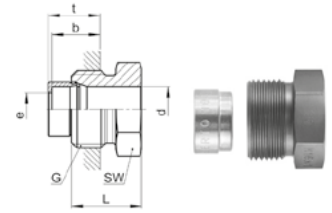
Anschlussnippel**Ecrou de raccordement mâle****Nipple connection****SO 11001**

Type -d -G	Mat.-Nr.	bar	SW	L	b	t	e	kg/100
G=Rohrgewinde (zylindrisch)	G=Filetage-gaz BSP (cylindrique)	G=BSP thread (parallel)						
SO 11001-8-1/4	118.0905.170	100	14	15.0	9.0	10.0	6.0	0.400
SO 11001-10-3/8	118.0905.280	100	17	15.0	9.0	10.0	8.0	0.620

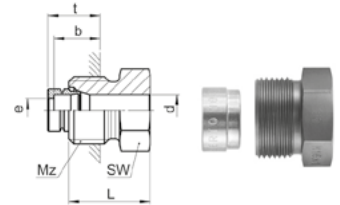
Anschlussnippel METR**Ecrou de raccordement mâle METR****Nipple connection METR****SO 11001 METR**

Type -d -Mz	Mat.-Nr.	bar	SW	L	b	t	e	kg/100
Mz=metrisches Gewinde (zylindrisch)	Mz=Filetage métrique (cylindrique)	Mz=Metric thread (parallel)						
SO 11001-10-M16x1	118.0901.284	100	17	15.0	9.0	10.0	8.0	0.600
SO 11001-12-M18x1	118.0901.332	100	19	15.0	10.0	11.0	9.0	0.700

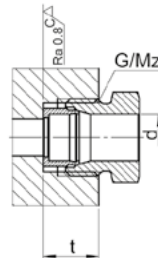
Anwendungsbeispiele:**Exemples d'utilisation:****Sample combinations:**

Aluminium

Aluminium

Aluminium

Gerade Verschraubung Union double Straight union

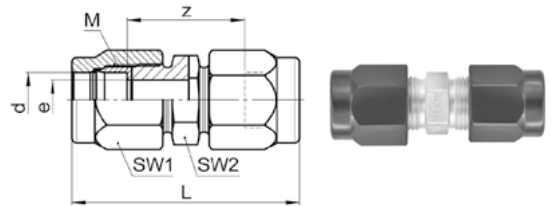
SO 11021

Type -d	Mat.-Nr.	bar	M	SW1	SW2	L	z	e	kg/100
SO 11021-8	118.1020.080	100	12x1.0	14	12	41.0	24.5	6.0	1.280
SO 11021-10	118.1020.100	100	14x1.0	17	14	47.0	25.5	8.0	2.000
SO 11021-12	118.1020.120	100	16x1.0	19	17	50.0	26.0	9.0	2.680
SO 11021-18	118.1020.180	100	24x1.5	30	24	64.0	37.0	15.0	8.310
SO 11021-22	118.1020.220	64	28x1.5	32	30	71.0	38.0	18.0	9.700
SO 11021-28	118.1020.280	64	36x2.0	41	36	82.0	49.0	24.0	17.900
SO 11021-35	118.1020.350	40	42x2.0	50	46	85.0	51.0	30.0	26.600

Gerade Verschraubung reduziert Union double réduite Straight reduction union

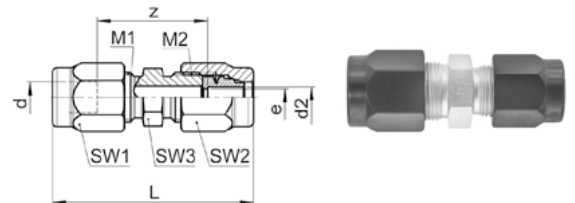
SO 11021 RED

Type -d-d2	Mat.-Nr.	bar	M1	M2	SW1	SW2	SW3	L	z	e	kg/100
SO 11021-12-10	118.1024.240	100	16x1.0	14x1.0	19	17	17	49.0	26.0	8.0	2.500

d=Rohraussen- \emptyset
e=kleinste Bohrung
L=Mass in montiertem Zustand

d= \emptyset extérieur du tube
e= \emptyset -min. de passage
L=après montage

d=tube outside diameter
e=minimum bore
L=installed length

Gerade Einschraubverschraubung

mit Conovor O-Ringabdichtung (FKM)

Union mâle

avec joint torique système Conovor (FKM)

Male adaptor union

with Conovor O-ring seal (FKM)

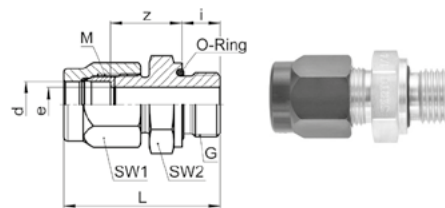
**SO 11124 OR**

Type -d-G	Mat.-Nr.	bar	M	SW1	SW2	L	D	i	t	O-Ring	z	e	kg/100
G=Rohrgewinde (zylindrisch)	G=Filetage-gaz BSP (cylindrique)	G=BSP thread (parallel)											
SO 11124-8-1/8 OR	118.1171.160	100	12x1.0	14	14	32.0	15.0	8.0	1.0	8.73x1.78	15.5	5.0	0.900
SO 11124-8-1/4 OR	118.1171.170	100	12x1.0	14	19	35.5	19.0	10.0	1.5	11.1x1.78	17.0	6.0	1.310
SO 11124-10-1/4 OR	118.1171.270	100	14x1.0	17	19	39.0	19.0	10.0	1.5	11.1x1.78	18.0	8.0	1.600
SO 11124-10-1/2 OR	118.1171.285	100	14x1.0	17	27	43.5	27.0	12.0	2.5	18.72x2.62	21.0	8.0	3.000
SO 11124-10-1 OR	118.1171.300	100	14x1.0	17	41	47.5	42.0	14.0	2.5	27.8x3.6	23.0	8.0	6.200
SO 11124-12-1/4 OR	118.1171.380	100	16x1.0	19	19	40.0	19.0	10.0	1.5	11.1x1.78	18.0	8.0	1.900
SO 11124-12-3/8 OR	118.1171.390	100	16x1.0	19	22	40.5	23.0	10.0	2.0	14.0x1.78	18.5	9.0	2.320
SO 11124-12-1/2 OR	118.1171.400	100	16x1.0	19	27	45.0	27.0	12.0	2.5	18.72x2.62	21.0	9.0	3.200
SO 11124-15-1/2 OR	118.1171.534	100	20x1.5	24	27	50.0	27.0	12.0	2.5	18.72x2.62	25.5	12.0	4.400
SO 11124-15-3/4 OR	118.1171.536	100	20x1.5	24	32	51.0	33.0	12.0	2.5	23.47x2.62	26.5	12.0	6.000
SO 11124-18-1/2 OR	118.1171.646	100	24x1.5	30	27	51.0	27.0	12.0	2.5	18.72x2.62	25.5	13.0	5.700
SO 11124-18-3/4 OR	118.1171.648	100	24x1.5	30	32	54.0	33.0	12.0	2.5	23.47x2.62	28.5	15.0	7.380
SO 11124-22-3/4 OR	118.1171.768	64	28x1.5	32	32	55.0	33.0	12.0	2.5	23.47x2.62	26.5	18.0	7.000
SO 11124-28-1 OR	118.1171.850	64	36x2.0	41	41	63.0	42.0	14.0	2.5	27.8x3.6	32.5	24.0	12.450
SO 11124-35-1 1/4 OR	118.1171.944	40	42x2.0	50	50	70.5	52.0	16.0	2.5	37.69x3.53	37.5	30.0	20.800

Gerade Einschraubverschraubung METR

mit Conovor O-Ringabdichtung (FKM)

Union mâle METR

avec joint torique système Conovor (FKM)

Male adaptor union METR

with Conovor O-ring seal (FKM)

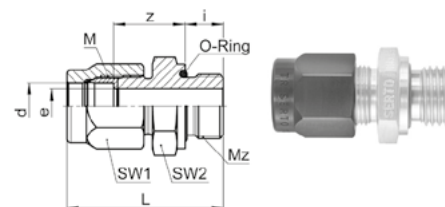
**SO 11124 OR METR**

Type -d-Mz	Mat.-Nr.	bar	M	SW1	SW2	L	D	i	t	O-Ring	z	e	kg/100
Mz=metrisches Gewinde (zylindrisch)	Mz=Filetage métrique (cylindrique)	Mz=Metric thread (parallel)											
SO 11124-10-M14x1.5 OR	118.1173.280	100	14x1.0	17	19	38.0	19.5	10.0	1.5	11.1x1.78	17.0	8.0	1.600
SO 11124-12-M12x1.5 OR	118.1173.320	100	16x1.0	19	17	39.0	17.5	10.0	1.5	9.25x1.78	17.0	6.0	1.700
SO 11124-15-M18x1.5 OR	118.1173.390	100	20x1.5	24	22	47.0	23.5	10.0	2.0	15.6x1.78	24.0	12.0	3.400

Fortsetzung nächste Seite

Suite à la prochaine page

Continued on next page

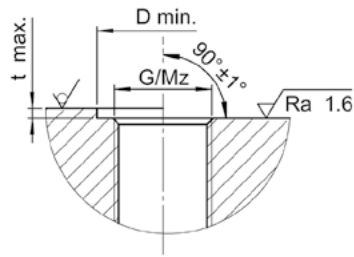
Einbauempfehlung:**Conseil de montage:****Recommendation for installation:****Einsatzbereich: Temperatur zwischen -20 °C und +120 °C**

Die Vorteile dieser O-Ringabdichtung:

- keine Dichtmittelreste in Geräten
- einwandfreie Abdichtung
- keine Beschädigung von Geräten durch konische Gewinde
- schnelle Montage

Conovor patentierte O-Ring Abdichtung

Champ d'application: Température entre -20 °C et +120 °C

Les avantages de cette étanchéité à joint torique:

- aucun reste de scellant dans les équipements
- une étanchéité parfaite
- aucun endommagement de l'équipement par le filetage conique
- facilité d'installation

Étanchéité à joint torique brevetée Conovor

Range of use: Temperature between -20 °C and +120 °C

Advantages of this O-ring seal:

- no sealing residues in devices
- perfect seal
- no damage to devices due to tapered thread
- rapid assembly

Conovor patented O-ring seal

Einstellbare Einschraubverschraubung

mit Conovor O-Ringabdichtung (FKM)

Union mâle orientable

avec joint torique système Conovor (FKM)

Adjustable male adaptor union

with Conovor O-ring seal (FKM)

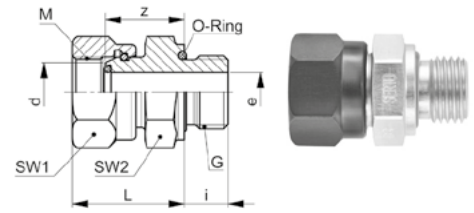

SO 11335 OR

Type -d-G	Mat.-Nr.	bar	M	SW1	SW2	L	D	i	t	O-Ring	z	e	kg/100
G=Rohrgewinde (zylindrisch)													
G=Filetage-gaz BSP (cylindrique)													
G=BSP thread (parallel)													
SO 11335-8-1/4 OR	118.1651.170	100	12x1.0	17	19	21.5	19.0	10.0	1.5	11.1x1.78	15.0	6.0	1.400
SO 11335-10-1/4 OR	118.1651.270	100	14x1.0	19	19	24.5	19.0	10.0	1.5	11.1x1.78	17.0	8.0	1.500
SO 11335-12-3/8 OR	118.1651.390	100	16x1.0	22	22	25.5	23.0	10.0	2.0	14.0x1.78	18.0	9.0	2.300
SO 11335-15-1/2 OR	118.1651.534	100	20x1.5	27	27	31.5	27.0	12.0	2.5	17.12x2.62	22.0	12.0	4.100
SO 11335-18-3/4 OR	118.1651.648	100	24x1.5	32	32	32.5	33.0	12.0	2.5	23.47x2.62	23.0	15.0	6.100
SO 11335-22-3/4 OR	118.1651.768	64	28x1.5	36	32	32.5	33.0	12.0	2.5	23.47x2.62	23.0	18.0	6.100
SO 11335-35-1 1/4 OR	118.1651.944	40	42x2.0	55	50	43.5	52.0	16.0	2.5	37.69x3.53	31.0	30.0	18.400

Anwendungsbeispiele:

Mit der einstellbaren Einschraubverschraubung lassen sich verschiedene Grundteile einfach verbinden. Kompakte Bauweise, schnelle Montage, einfache Fixierung der Komponenten in der gewünschten Stellung.

d = Kenngröße: entspricht dem Rohraussen- \emptyset des Armaturenanschlusses SO 10021, der gegen die einstellbare Einschraubverschraubung SO 11335 OR ausgetauscht werden kann.

Montagehinweis: Anschlussmutter mit 1/8 Umdrehung anziehen. Wir empfehlen eine zusätzliche Schmierung auf der Planfläche.

Exemples d'utilisation:

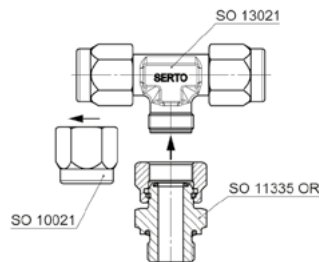

L'union orientable mâle permet de connecter facilement différents corps de raccord. Construction compacte, montage rapide, fixation facile des composants dans la position désirée.

d = dimension nominale: correspond au dia. extérieur du tube de l'écrou et bague de raccordement SO 10021, lequel peut être échangé contre l'union mâle orientable SO 11335 OR.

Note d'installation: Serrez l'écrou de 1/8 de tour. Nous recommandons une lubrification supplémentaire sur la surface plane.

Sample combinations:

With the adjustable male adaptor union different basic components can easily be connected. Compact construction, quick assembly, and easy fixing of the components in the desired position.

d = nominal size: corresponds to tube outside diameter of the nut connection SO 10021 which can be replaced by the adjustable male adaptor union SO 11335 OR.

Assembly information: Tighten the union nut with 1/8 turn. We recommend additional lubrication on the plane surface.

Einbauempfehlung:

Conseil de montage:

Recommendation for installation:

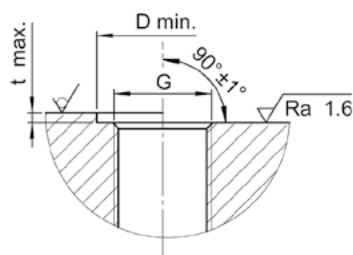

d=Rohraussen- \emptyset
e=kleinste Bohrung
L=Mass in montiertem Zustand

d= \emptyset extérieur du tube
e= \emptyset -min. de passage
L=après montage

d=tube outside diameter
e=minimum bore
L=installed length

Einstellbare Verschraubung

mit O-Ringabdichtung (FKM)

Union orientable

avec joint torique (FKM)

Adjustable union

with O-ring seal (FKM)

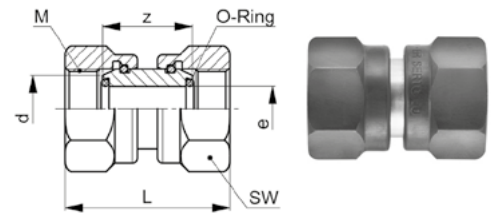
SO 11345 OR

Type -d	Mat.-Nr.	bar	M	SW	L	O-Ring	z	e	kg/100
SO 11345-8 OR	118.1350.080	100	12x1.0	17	29.0	6.0x1.0	16.0	6.0	1.200
SO 11345-10 OR	118.1350.100	100	14x1.0	19	33.0	8.0x1.0	18.0	8.0	1.600
SO 11345-12 OR	118.1350.120	100	16x1.0	22	33.0	9.0x1.5	18.0	9.0	2.200
SO 11345-15 OR	118.1350.150	100	20x1.5	27	41.0	12.0x1.5	22.0	12.0	4.100
SO 11345-18 OR	118.1350.180	100	24x1.5	32	41.0	15.0x2.0	22.0	15.0	5.600
SO 11345-22 OR	118.1350.220	64	28x1.5	36	41.0	18.0x2.0	22.0	18.0	6.700

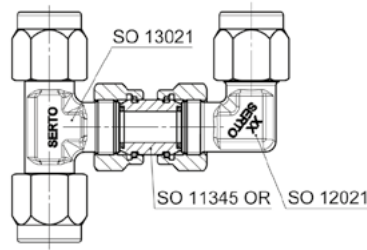
Anwendungsbeispiele:**Exemples d'utilisation:****Sample combinations:****Einsatzbereich: Temperatur zwischen -20 °C und +120 °C**

Mit der einstellbaren Verschraubung lassen sich verschiedene Grundteile einfach verbinden. Kompakte Bauweise, schnelle Montage, einfache Fixierung der Komponenten in der gewünschten Stellung.

Beachten Sie auch die Möglichkeiten mit SO 11335 OR.

d = Kenngröße: entspricht dem Rohraussen- \varnothing des Armaturenanschlusses SO 10021, der gegen die einstellbare Verschraubung SO 11345 OR ausgetauscht werden kann.

Montagehinweis: Beide Anschlussmutter mit 1/8 Umdrehung anziehen. Wir empfehlen eine zusätzliche Schmierung auf der Planfläche.

Champ d'application: Température entre -20 °C et +120 °C

L'union orientable permet de connecter facilement différents corps de raccord. Construction compacte, montage rapide, fixation facile des composants dans la position désirée.

Voir également les possibilités avec SO 11335 OR.

d = dimension nominale: correspond au dia. extérieur du tube de l'écrou et bague de raccordement SO 10021, lequel peut être échangé contre l'union orientable SO 11345 OR.

Note d'installation: Serrez les deux écrous de 1/8 de tour. Nous recommandons une lubrification supplémentaire sur la surface plane.

Range of use: Temperature between -20 °C and +120 °C

With the adjustable union different basic components can easily be connected. Compact construction, quick assembly, and easy fixing of the components in the desired position.

See SO 11335 OR for additional possibilities.

d = nominal size: corresponds to tube outside dia. of the nut connection SO 10021 which can be replaced by the adjustable union SO 11345 OR.

Assembly information: Tighten both union nuts with 1/8 turn. We recommend additional lubrication on the plane surface.

Aluminium

Aluminium

Aluminium

Gerade Schottverschraubung

Durchführungslänge max. 16 mm

Union double traversée de cloison

pour cloison max. 16 mm

Panel mount union

max. panel thickness 16 mm

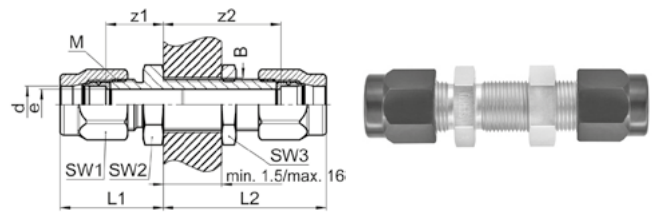
SO 11524

Type-d	Mat.-Nr.	bar	M	SW1	SW2	SW3	L1	L2	B	z1	z2	e	kg/100
SO 11524-10	118.1540.100	100	14x1.0	17	19	19	26.0	43.5	14.5	15.5	33.0	8.0	2.900
SO 11524-12	118.1540.120	100	16x1.0	19	22	22	28.0	46.0	16.5	16.0	34.0	9.0	4.300
SO 11524-18	118.1540.180	100	24x1.5	30	30	30	37.0	56.0	24.5	23.5	42.5	15.0	12.400
SO 11524-22	118.1540.220	64	28x1.5	32	36	36	41.0	61.0	28.5	24.5	44.5	18.0	15.800

Sechskantmutter siehe SO 10006 METR

Ecrou à six pans voir SO 10006 METR

Hexagon nut see SO 10006 METR

Winkelverschraubung

Coude

Elbow union

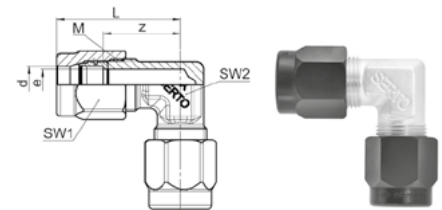
SO 12021

Type-d	Mat.-Nr.	bar	M	SW1	SW2	L	z	e	kg/100
SO 12021-10	118.2000.100	100	14x1.0	17	14	31.0	20.5	8.0	2.400
SO 12021-12	118.2000.120	100	16x1.0	19	17	33.5	21.5	9.0	3.200
SO 12021-15	118.2000.150	100	20x1.5	24	19	41.0	28.5	12.0	6.000
SO 12021-18	118.2000.180	100	24x1.5	30	22	44.0	30.5	15.0	9.500
SO 12021-22	118.2000.220	64	28x1.5	32	27	48.0	31.5	18.0	10.900
SO 12021-28	118.2000.280	64	36x2.0	41	32	56.5	40.0	24.0	20.100
SO 12021-35	118.2000.350	40	42x2.0	50	41	62.0	45.0	30.0	31.600

d=Rohrassen-ø
e=kleinste Bohrung
L=Mass in montiertem Zustand

d=ø extérieur du tube
e=ø-min. de passage
L=après montage

d=tube outside diameter
e=minimum bore
L=installed length

Winkel-Schottverschraubung

Durchführungslänge max. 5 mm

Coude traversée de cloison

pour cloison max. 5 mm

Panel mount elbow union

max. panel thickness 5 mm

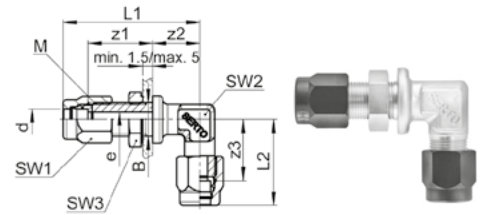
SO 12721

Type -d	Mat.-Nr.	bar	M	SW1	SW2	SW3	L1	L2	B	z1	z2	z3	e	kg/100
SO 12721-10	118.2700.100	100	14x1.0	17	17	19	52.0	34.0	14.5	23.0	18.0	23.5	8.0	4.100

Sechskantmutter siehe SO 10006 METR

Ecrou à six pans voir SO 10006 METR

Hexagon nut see SO 10006 METR

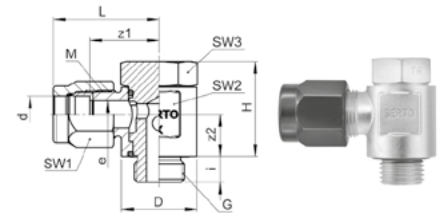
Schwenkverschraubung**Coude banjo****Single banjo****SO 12824**

Type -d-G	Mat.-Nr.	bar	M	SW1	SW2	SW3	L	D	H	i	z1	z2	e	kg/100
SO 12824-8-1/8	118.2841.160	100	12x1.0	14	14	13	26.0	15.0	20.5	6.5	17.5	9.0	5.5	1.400
SO 12824-10-1/4	118.2841.270	100	14x1.0	17	19	17	32.0	20.0	28.0	8.5	21.0	12.5	6.5	2.900
SO 12824-12-3/8	118.2841.390	100	16x1.0	19	24	22	35.0	25.0	31.5	8.5	23.0	14.0	8.5	4.800
SO 12824-15-1/2	118.2841.534	100	20x1.5	24	30	27	42.0	30.0	38.0	10.0	29.5	17.0	12.0	8.400

O-Ring: FKM

Joint: FKM

O-Ring: FKM

T-Verschraubung

Té égal

Tee union

SO 13021

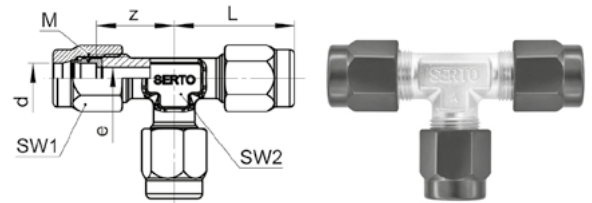

Type-d	Mat.-Nr.	bar	M	SW1	SW2	L	z	e	kg/100
SO 13021-10	118.3000.100	100	14x1.0	17	14	31.0	20.5	8.0	3.400
SO 13021-12	118.3000.120	100	16x1.0	19	17	33.5	21.5	9.0	4.500
SO 13021-15	118.3000.150	100	20x1.5	24	19	39.0	26.0	12.0	8.100
SO 13021-18	118.3000.180	100	24x1.5	30	22	44.0	30.5	15.0	13.300
SO 13021-22	118.3000.220	64	28x1.5	32	27	48.0	31.5	18.0	15.800
SO 13021-28	118.3000.280	64	36x2.0	41	32	56.5	40.0	24.0	28.400
SO 13021-35	118.3000.350	40	42x2.0	50	41	62.0	45.0	30.0	43.300

T-Verschraubung reduziert

Té réduit

Tee reduction union

SO 13021 RED

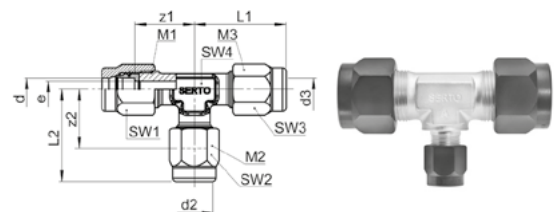

Type-d-d2-d3	Mat.-Nr.	bar	M1	M2	M3	SW1	SW2	SW3	SW4	L1	L2	z1	z2	e	kg/100
SO 13021-18-10-18	118.3004.584	100	24x1.5	14x1.0	24x1.5	30	17	30	22	43.0	36.5	29.5	28.0	8.0	10.700
SO 13021-18-12-18	118.3004.599	100	24x1.5	16x1.0	24x1.5	30	19	30	22	43.0	38.0	29.5	28.0	9.0	10.900
SO 13021-22-12-22	118.3004.740	64	28x1.5	16x1.0	28x1.5	32	19	32	27	48.0	40.0	31.5	30.0	9.0	13.300
SO 13021-22-18-22	118.3004.862	64	28x1.5	24x1.5	28x1.5	32	30	32	27	48.0	45.0	31.5	33.5	15.0	15.600

Kreuzverschraubung

Croix égale

Cross union

SO 14021

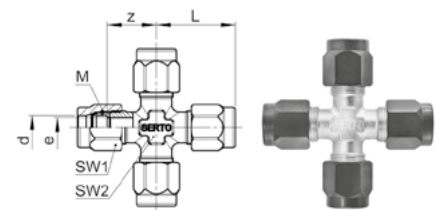

Type-d	Mat.-Nr.	bar	M	SW1	SW2	L	z	e	kg/100
SO 14021-12	118.4000.120	100	16x1.0	19	14	33.5	21.5	9.0	5.400

d=Rohrussen- \varnothing
e= kleinste Bohrung
L= Mass in montiertem Zustand

d= \varnothing extérieur du tube
e= \varnothing -min. de passage
L=après montage

d=tube outside diameter
e=minimum bore
L=installed length

SERTO®

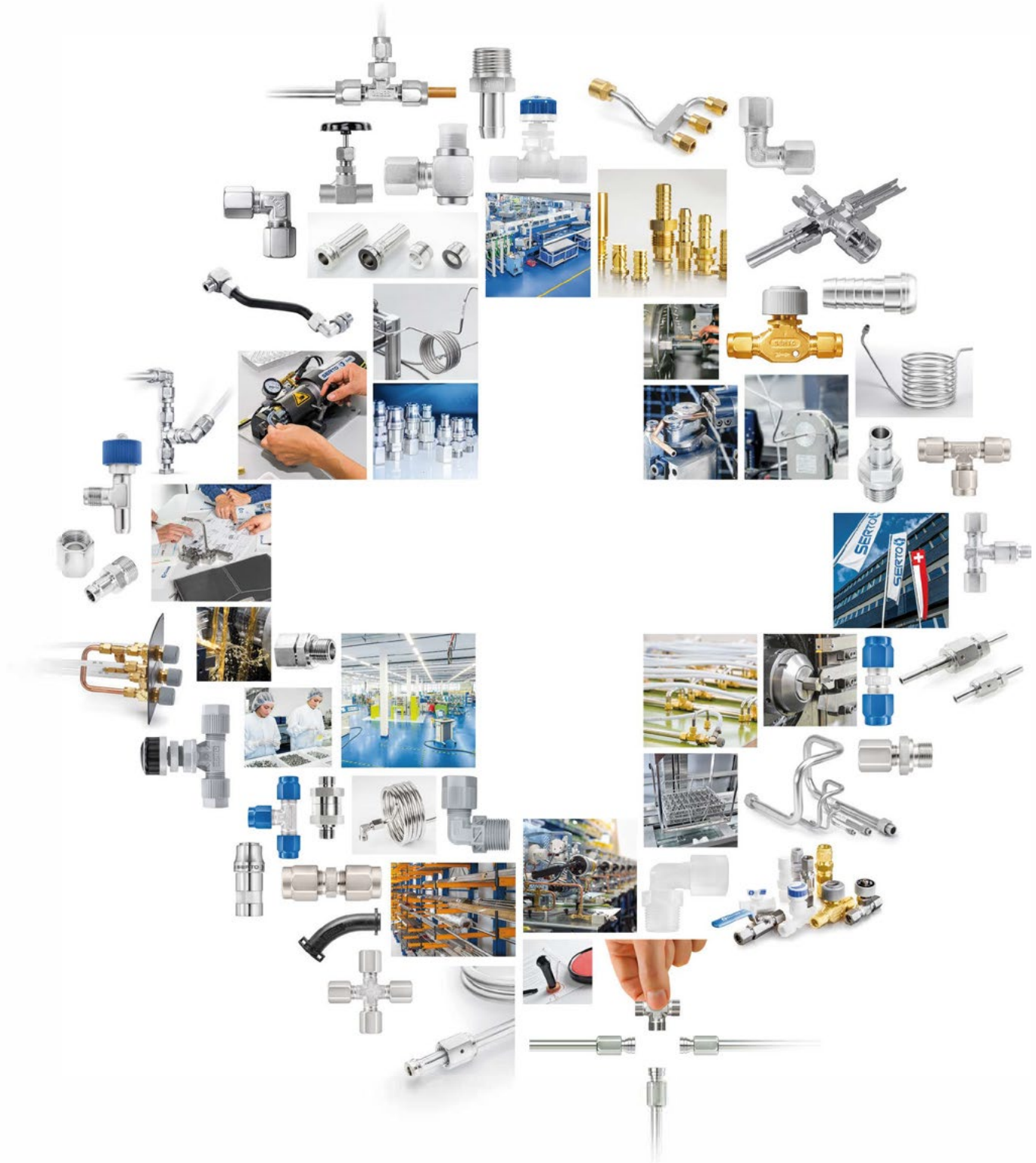

Schweiz

SERTO AG
 CH-8500 Frauenfeld
 Tel. +41 52 368 11 11
 info-ch@serto.com

www.serto.com

Deutschland

SERTO GmbH
 D-34123 Kassel
 Tel. +49 561 58004-0
 info-de@serto.com

Frankreich

SERTO S.A.R.L.
 F-77164 Ferrières en Brie
 Tel. +33 1 64 30 38 38
 info-fr@serto.com

Italien

SERTO Italiana S.r.l.
 I-24030 Brembate di Sopra (BG)
 Tel. +39 035 333 000
 info-it@serto.com